

SUBMITTAL: FIRE-RATED FX SECURITY/DETENTION FIRE EXTINGUISHER, VALVE AND HOSE CABINETS PAGE 1 OF 3

JL security and detention cabinets for fire extinguishers, fire hoses or fire department valves are constructed to meet maximum security requirements in areas where fire protection is required. All recessed models have heavy-duty masonry anchors welded to the frame and a wide selection of lock preps and locks.



SFXFC-11DSPI-25.A
with Optional Detention
Deadlock Airteq 5010
Installed

Fire-Rating: The recessed and semi-recessed Fire-FX™ cabinets are Intertek listed and labeled as an approved membrane penetration firestop system for up to 2 hours in accordance with ASTM-E814 when properly installed in a wall assembly according to installation instructions. The installation of this fire-rated cabinet which lacks a cabinet door or a condition in which the door is left ajar, will void the fire rating.

SPECIFICATIONS:

Door & Trim: 12 gauge (0.27 cm) steel with white powder coat finish or 14 gauge #4 satin finish stainless door. Flush cabinet doors are mounted in a 5/8" door stop and attached by a heavy-duty continuous hinge.

Trim Style & Depth: 1-1/2" wide trim on frame. Available in *Recessed* with flat trim, *Semi-recessed* with 2-1/2" deep square profile trim.

Tub: FX models feature an inner tub of the same material and finish as the frame surrounded by fire-resistant material, and a painted steel, outer tub. Heavy-duty masonry anchors are provided on recessed & semi recessed models.

Locks: See page 2 and 3 for lock and lock prep choices.

Knockouts: Knockouts are not provided on Fire-Rated Cabinets. Instructions for Knockouts in the field are provided, and must be strictly adhered to, to maintain fire rating.

CABINET DESCRIPTION, SIZE & WALL OPENING TABLE—PLEASE USE SELECTION TABLE ON PAGE 2, TO ORDER												
TRIM & DOOR MATERIAL & SERIES			TUB I.D. W x H x D in Inches			FRAME O.D. W x H Inches		WALL OPENING FIRE-RATED FX			APPROX SHIP WT lbs	RECOMMENDED HOSE RACK & EXTINGUISHER
STEEL	STAINLESS	TRIM STYLE	A	B	C	E	F	Width	Height	Depth		
SECURITY FIRE EXTINGUISHER CABINETS (SFC)												
SFXFC-11	SSFXFC-31	Flat Trim	10-½	24	7	13-½	27	12-½	26-½	8	41	Cosmic & Galaxy 2.5-10, Mercury 2.5-5, Sentinel 5
SFXFC-12	SSFXFC-32	2-1/2" Square Trim	10-½	24	7	13-½	27	12-½	26-½	5-½	45	
SFXFC-15	SSFXFC-35	Flat Trim (Lg Tub)	12	27	8-½	15	30	14	29-½	10	54	Any Cosmic, Galaxy, Mercury, Saturn 15, Sentinel 5
SFXFC-16	SSFXFC-36	2-½" Square Trim (Lg Tub)	12	27	8-½	15	30	14	29-½	7-½	56	
SECURITY VALVE CABINETS (SVC)												
SFXVC-11	SSFXVC-31	Flat Trim	18	18	8-½	21	21	20	20-½	9-½	53	1-½" or 2-½" Fire Department Valve
SFXVC-12	SSFXVC-32	2-½" Square Trim	18	18	8-½	21	21	20	20-½	7	54	
SECURITY HOSE CABINETS (SHC)												
SFXHC-11	SSFXHC-31	Flat Trim	32-¾	34-¾	8	35-¾	37-¾	34-¾	36-¾	9	132	1-½" or 2-½" Hose Rack, & Extinguisher, or F.D. Valve & Extinguisher
SFXHC-12	SSFXHC-32	2-½" Square Trim	32-¾	34-¾	8	35-¾	37-¾	34-¾	36-¾	6-½	157	

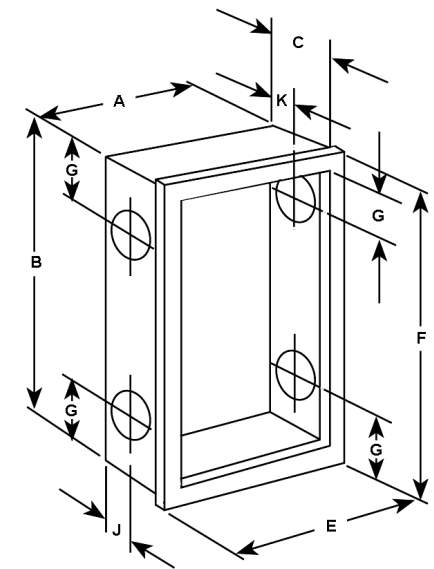

All Models meet the 4" ADA projection requirement

 JL INDUSTRIES 9702 Newton Av S. Bloomington, MN 55431	800-554-6077 sales@activarcpg.com www.activarcpg.com	Distributor:	Project:	
		Contractor:	Approved By:	
		Date:	Quantity:	Architect:
		Scale: N/A	Pages: 1 of 3	Item #

SUBMITTAL: FIRE-RATED FX SECURITY/DETENTION FIRE EXTINGUISHER, VALVE AND HOSE CABINETS PAGE 2 OF 3

Select Material, Series, Finish & Trim Style Below - Example SFXFC-11MCP-02.B.1

QTY	Material	Series	Finish	Trim Style
<input type="checkbox"/>	S Steel 12ga	<input type="checkbox"/> FXFC Fire-Rated FE Cabinet	<input type="checkbox"/> 1 Powdercoat	<input type="checkbox"/> 1 Flat Square
<input type="checkbox"/>	SS 304 Stainless 14ga		<input type="checkbox"/> 3 #4 Stainless	<input type="checkbox"/> 2 2-½" Square
		<input type="checkbox"/> VCFX Fire-Rated Valve Cabinet	<input type="checkbox"/> 1 Powdercoat	<input type="checkbox"/> 5 Flat Square, Lg. Tub
			<input type="checkbox"/> 3 #4 Stainless	<input type="checkbox"/> 6 2½" Square, Lg. Tub
		<input type="checkbox"/> HCFX Fire-Rated Hose Cabinet	<input type="checkbox"/> 1 Powdercoat	<input type="checkbox"/> 1 Flat Square
			<input type="checkbox"/> 3 #4 Stainless	<input type="checkbox"/> 2 2-½" Square

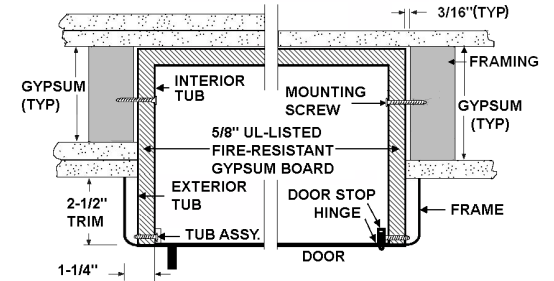

TYPICAL FIRE-RATED INSTALLATION

Select Lock Type & Prep, Finish Color, Silkscreen or Engraved Lettering

Lock Type		
<input type="checkbox"/> MCP		Prepped for Cylinder Lock
<input type="checkbox"/> MCP-02	Mortise Cam Latch	Installed - Kaba Ilco Cylinder Lock w/Std Cam Other: Model & Mfg: _____
<input type="checkbox"/> MDP		Prepped for Cylinder Lock
<input type="checkbox"/> MDP-03	Mortise Deadbolt	Installed - Kaba Ilco Cylinder Lock w/Adams Rite Cam
<input type="checkbox"/> MDP-07		Installed - Temporary Construction Core Best Cylinder w/Std Cam Other: Model & Mfg: _____
<input type="checkbox"/> DSPP-25		Prepped for Airteq 5017 Lock
<input type="checkbox"/> DSPI-25	Detention Slam Lock	Installed - Airteq 5017 Lock Other: Model & Mfg: _____
<input type="checkbox"/> DDPP-17		Prepped for Airteq 5010 Lock
<input type="checkbox"/> DDPI-17	Detention Deadbolt	Installed - Airteq 5010 Lock Other: Model & Mfg: _____
<input type="checkbox"/> MLPP-19	Mogul Detention	Prepped for Airteq Mogul Lock 5010M
<input type="checkbox"/> MLPI-19	Deadbolt	Installed - Airteq Mogul Lock 5010M Other: Model & Mfg: _____

Finish Color	
<input type="checkbox"/> A	White (Std)
<input type="checkbox"/> B	Black
<input type="checkbox"/> C	Red
<input type="checkbox"/> D	Stainless
<input type="checkbox"/>	Other Color

Optional Silkscreen/Engraved Lettering (Stainless—Engraving Only)	
<input type="checkbox"/> 1	ENFELVB Engraving, Fire Extinguisher Lettering, Vertical, Black
<input type="checkbox"/> 2	ENFELVR Engraving, Fire Extinguisher Lettering, Vertical, Red
<input type="checkbox"/> 3	SSFELVB Silk Screen, Fire Extinguisher Lettering, Vertical, Black
<input type="checkbox"/> 4	SSFELVR Silk Screen, Fire Extinguisher Lettering, Vertical, Red
<input type="checkbox"/> 5	ENFELVW Engraving, Fire Extinguisher Lettering, Vertical, White
<input type="checkbox"/> 6	SSFELVW Silk Screen, Fire Extinguisher Lettering, Vertical, White
<input type="checkbox"/> 7	SSFELHR Silk Screen, Fire Extinguisher Lettering, Horizontal, Red
<input type="checkbox"/> 8	SSFELHB Silk Screen, Fire Extinguisher Lettering, Horizontal, Black
<input type="checkbox"/> 9	SSFELHW Silk Screen, Fire Extinguisher Lettering, Horizontal, White

Note: For other locks not listed (prepped or installed), manufacturer may require a sample of the lock. See page 3 for more lock details

Additional Accessories, Sold Separately (see separate submittal)

<input type="checkbox"/> FDVO Decal Fire Department Valve Octagonal 6 x 6"	<input type="checkbox"/> Black Vertical FE Letters LDCVBFE
<input type="checkbox"/> 1403 Decal Fire Hose Black/Red Horizontal Letters 4" x 9"	<input type="checkbox"/> Red Vertical FE Letters LDCVRFE
<input type="checkbox"/> LDCHRFDV-R Diecut Fire Dept. Valve Horizontal 10-1/4" x 4-3/8"	<input type="checkbox"/> White Vertical FE Letters LDCVWFE
<input type="checkbox"/> LDCVRFDV Diecut Fire Dept Valve Vertical 3/4" x 21½"	<input type="checkbox"/> Black Horizontal FE Letters LDCHBFE
<input type="checkbox"/> LDCVRFDV-R Diecut Fire Dept Valve Vertical Reverse 3/4" x 21½"	<input type="checkbox"/> Red Horizontal FE Letters LDCHRFE
<input type="checkbox"/> LDCHRFDV Diecut Fire Department Valve Ascending 1" x 17"	<input type="checkbox"/> White Horizontal FE Letters LDCHWFE
<input type="checkbox"/> LDCVRFSCV-R Diecut Fire Sprinkler Control Valve Vertical .3/4" x 18"	<input type="checkbox"/> Custom Engraved or Silkscreen Lettering

(Check Here and Attach Separate Submittal to Order)

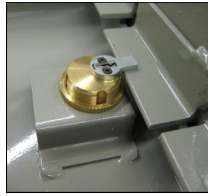
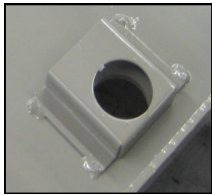
**MORTISE CAM LATCH**

MCP: Prepped for mortise cylinder lock by others. Cylinder lock must be: 1-1/8" diameter x 1-1/4" long mortise cylinder with standard cam. Cylinders by others require threaded locknut ring.

MCP-02: Includes installed mortise cylinder Kaba Ilco 7205SC1, 1-1/8" Dia x 1-1/4" long mortise cylinder with standard cam (PN: 06431), 2 keys (PN: 06431-KEY) and lock nut ring (PN: 0646).

MORTISE DEADBOLT

MDP: Prepped for mortise deadbolt cylinder lock by others. Cylinder lock must be: 1-1/8" diameter x 1-1/4" long mortise cylinder with Adams Rite cam. Longer lengths require adjustable lock collar (PN: SL-ALC).

MDP-03: Includes installed Kaba Ilco 7205SC2, 1-1/8" x 1-1/4" long mortise cylinder with Adams Rite cam (PN: 06441) and includes 2 keys (PN: 06431-KEY).

MDP-07: Includes installed temporary construction core mortise deadbolt cylinder Best 1E74C181RP3626, 1-1/8" diameter x 1-1/4" long mortise cylinder with C181 Adam Rite cam (PN: SL-1E74). Operation key (PN: 040004) & control key (PN: 040005) to remove the construction core ordered separately.

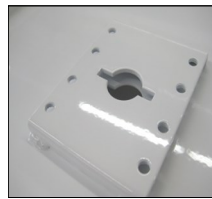
**DETENTION SLAM LOCK**

DSPP-25: Prepped for detention slam lock Airteq 5017 with standard bevel by others.

DSPI-25: Includes installed Airteq 5017 medium security for slam-locking with stainless steel latchbolt 1" x 7/16" bolt throw (PN: DDI-5017). Keys sold separately (PN: DDK-5017).

DETENTION DEADBOLT

DDPP-17: Prepped for detention deadbolt lock Airteq 5010. This mounting also accommodates Southern Folger 1010A.

DDPI-17: Includes installed Airteq 5010, medium security deadbolt, with zinc plated steel bolt 1-1/2" x 3/4" and 5/8" bolt throw (PN: DDI-5010). Keys sold separately (PN: DDK-5010).

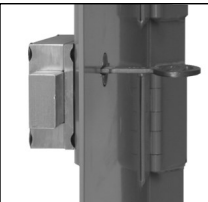
**DETENTION DEADBOLT MOGUL LOCK**

MLPP-19: Prepped for detention deadbolt with mogul cylinder Airteq 5010M.

MLPI-19: Includes installed Airteq 5010M medium security deadbolt with mogul key cylinder, zinc plated steel bolt 1-1/2" x 1/2" and 5/8" throw (PN: DDI-5010M). Includes 2 keys (PN: DDK-5010M).



It is the responsibility of the customer to communicate specifications and product performance requirements that are needed for their application. This document is intended to convey potential product configurations and offerings. It is not to be used to imply or represent a specification or rating, of finished products shipped. Detailed, specific submittals can be created upon request. It is the responsibility of the customer to specify product accordingly to comply with local laws, codes, and ordinances.