



FIRE PROTECTION CATALOG

DIVISION 10 44 00

FIRE EXTINGUISHERS
FIRE PROTECTION CABINETS
FIRE BLANKETS

DIVISION 21 12 00

FIRE SUPPRESSION HOSES
HOSE RACKS VALVES & NOZZLES



ACTIVAR CONSTRUCTION PRODUCTS GROUP INC.



OUR BRANDS

Since 1947, we have been known for developing, manufacturing, and distributing quality products for the commercial construction industry. Activar Construction Products Group now offers products under the brand names of JL Industries, Air Louvers, Maxam Metal Products, Dur-Red Products, and Cato. With multiple manufacturing plants and the most stocking locations in the industry, we provide fast local distribution to most major metropolitan areas of the US.

JL Industries:

Since 1947, the legacy brand of JL Industries has been designing, testing, and manufacturing quality products. With knowledgeable factory sales reps who work closely with our distribution partners nationwide, we support you from the start of a project to closeout. We provide you with easy access to resources such as specifications, BIM information and product documentation directly on our website. We are proud of our reputation for excellence and reliability in the industry

Cato:

Cato has been providing quality products since 1984; and is best known for manufacturing a complete line of plastic fire extinguisher cabinets and plastic protective covers for fire alarms. We are excited to be able to offer this new group of products to our fire protection distributors.

We were the first U.S. manufacturer of plastic fire extinguisher cabinets, offering surface mount or semi recessed options. They are able to accommodate most extinguishers models in 5, 10, and 20 lb. sizes. We stock our most popular models of Cato Chief cabinets in many of our warehouses for quick delivery.

(Pictured: Our stocked red Chief cabinet with red hammer)

Find documentation and the most current product information on our website at activarcpg.com



STOCKING WAREHOUSE LOCATIONS:

We offer 1-3 day shipping on hundreds of our most popular products from our centrally-located warehouses in the U.S. With the combined resources of our three manufacturing facilities, you can create your own distinctive cabinet with the size and features you need, for the look you want. Just ask us!

WARRANTY

All fire protection products carry a one-year warranty after date of shipment against defects in materials and workmanship. We will replace or repair any product found defective within this period at our discretion. No other warranty express or implied is valid. Fire extinguishers may carry a longer warranty.

AMERICANS WITH DISABILITIES ACT (ADA) GUIDELINES

PROJECTION REQUIREMENTS

The federal regulations for ADA Standards for protruding objects such as fire extinguisher cabinets, specify that "objects projecting from walls with their leading edges between 27" and 80" above the finished floor (AFF) shall protrude no more than 4" into walkways.

MOUNTING HEIGHTS

The NFPA and ADA have created guidelines for the mounting of cabinets and extinguishers to provide safety and easy access to the equipment. According to the ADA Standards, the cabinet handle cannot be mounted higher than 48" AFF for applications which allow for only a forward approach in a wheelchair to the object.

These are national standards which are subject to change by local authorities having jurisdiction. Visit ada.gov for details.

Look for Model Numbers in Blue to find cabinets that meet the ADA 4" Projection Requirement.



TABLE OF CONTENTS

FIRE EXTINGUISHERS

Cosmic, Galaxy, Saturn, Mercury	4
Sentinal, Nebula, Granadier	4
Orbit, Wheeled Fire Extinguishers	5

CABINETS

ARCHITECTURAL SERIES CABINETS:

Ambassador - Steel	6-7
Academy - Aluminum	6-7
Cosmopolitan - Stainless Steel	6-7
Panorama - Steel, Aluminum, Stainless Steel, Brass, Bronze	6-7
Cavalier - Brass, Bronze	8-9
Clear Vu - Steel, Aluminum, Stainless Steel, Brass, Bronze	8-9
Embassy - Steel, Aluminum, Stainless Steel, Brass, Bronze	10-11
Orbit Cabinet - Steel, Aluminum, Stainless Steel, Brass, Bronze	10-11
Royal 3600 Series - Steel, Aluminum, Stainless Steel	10-11
Crownline Valve/Hose - Steel, Aluminum, Stainless Steel	12-13
Architectural Door Styles	14
Architectural Cabinets Part Number Guide	15

ECONOMY SERIES CABINETS:

Classic - Galvanized Steel, Aluminum	16-17
Decorline - Steel, Aluminum	16-17
Economyline - Steel, Aluminum	16-17
SMB - Steel	18-19
SM - Aluminum	18-19
FB - Fiberglass	18-19
Cato Chief - Plastic	20
Cato Island Chief - Plastic	20
Cato Chief Pull to Open - Plastic	21
Cato Chief Semi Recessed - Plastic	21
Cato Warrior - Plastic	22
Cato Customizer Panel	22
Cato Accessories	23
Cato Cabinet Part Number Guide	24
Cato Fire Alarm Covers - Plastic	25

SPECIALTY CABINETS:

Security - Steel, Stainless Steel	26-27
School Series - Steel, Stainless Steel	26-27
HRA Series	26-27

ACCESSORIES

Decals and Die Cuts	28-29
Plastic Signs	29
Miscellaneous Accessories	30-31
Optional Color & Metal Finishes	31



ABOUT JL INDUSTRIES FIRE-FX2™ FIRE-RATED CABINETS

JL Industries led the industry by introducing the first pre-lined Fire-Rated Cabinets in 1991. Those cabinets have changed and simplified the installation process forever. In 2015, JL took the next step and eliminated the heavy gypsum wallboard to line cabinets, by replacing it with lightweight, mineral wool insulation.

UL

Tested to maintain one and two-hour fire rated wall barriers, in accordance with ANSI/UL-1479 (ASTM E814 and ULC.CAN S115) for membrane penetration firestops.

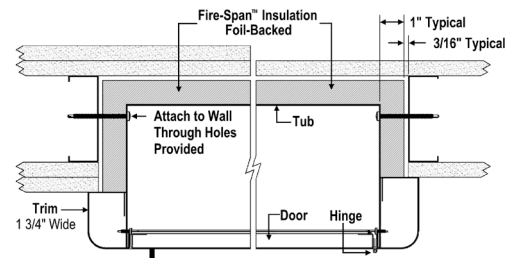

This view is for metal or wood framing installation

It is the responsibility of the customer to communicate specifications and product performance requirements that are needed for their application. This document is intended to convey potential product configurations and offerings. It is not to be used to imply or represent a specification or rating, of finished products shipped. Detailed, specific submittals can be created upon request. It is the responsibility of the customer to specify product accordingly to comply with local laws, codes, and ordinances.



FIRE EXTINGUISHERS

COSMIC EXTINGUISHERS: MULTI-PURPOSE DRY CHEMICAL

CLASS A,B,C FIRES



These units contain specially fluidized and siliconized mono ammonium phosphate powder, which smothers and breaks the chain reaction on Class B fires, fuses and insulates Class A fires and is a non-conductor of electricity. Non-toxic.

Operation: Squeeze the lever, which opens the valve, allowing the chemical to be forced out. Upright squeeze grip operation approved to -65°F (-52°C).

Construction: Heavy-duty steel cylinder with rugged metal valve and siphon tube, replaceable molded valve stem seal, visual pressure gauge, pull pin and upright squeeze grip. Corrosion and impact-resistant powder coat finish.

GALAXY EXTINGUISHERS: REGULAR DRY CHEMICAL

CLASS B,C FIRES



These models contain a siliconized sodium bicarbonate base, the traditional dry chemical. Cleanup after use is generally easy, because the chemical does not normally bake to a hot metal surface. Non-toxic.

Operation: Squeeze the lever, which opens the valve, allowing the chemical to be forced out. Upright squeeze grip operation approved to -65°F (-52°C).

Construction: Heavy-duty steel cylinder with rugged metal valve and siphon tube with replaceable valve stem seal, visual pressure gauge pull pin and upright squeeze grip.

SATURN EXTINGUISHERS: CLASS A:K WET CHEMICAL

CLASS A, K FIRES



A low "pH" potassium acetate solution is discharged in a fine mist that provides excellent range while preventing splashing and creating an effective saponification foam-type blanket necessary for suppressing liquid cooking media fires.

Operation: Squeeze the lever, which opens the valve, allowing the chemical to be forced out.

Construction: Stainless steel cylinder with protective nozzle tip orifice seal and non-metallic nozzle tip finger guard. Industry standard horn and nozzle design. Name plate shows only the class "K" symbol.

MERCURY EXTINGUISHERS: HALOTRON®

CLASS A,B,C FIRES



Contains the clean extinguishing agent Halotron® 1, which is EPA-approved, government-accepted and specified. This agent discharges as a liquid, then quickly evaporates, leaving no residue to clean up afterwards. Electrically non-conductive.

Operation: Squeeze the lever, which opens the valve, allowing the chemical to be forced out. Temperature range from -40°F to +120°F.

Construction: Drawn steel cylinder with steel siphon tubes, power cone discharge stream, upright squeeze grip visual pressure gauge and corrosion-resistant paint finish

SENTINEL EXTINGUISHERS: CARBON DIOXIDE

CLASS B,C FIRES



This extinguisher contains liquid carbon dioxide under pressure.

Operation: Squeeze the lever, which opens the valve, allowing the carbon dioxide to be forced out. The discharge, which changes into a gas and appears as a smothering cloud of white snow, is then directed to the fire through a funnel-shaped horn. Electrically non-conductive.

Construction: Lightweight, high-pressure, aluminum cylinder with O-ring seal and straight thread all-metal valve fits all sizes. The Sentinel is absolutely rust-free and up to 30% lighter than CO₂ units with steel cylinders.

NEBULA EXTINGUISHERS: WATER MIST FOR ELECTRICAL

CLASS A,C FIRES



This non-toxic water mist extinguisher is ideal for Class A fires and where a potential Class C (electrical) hazard exists. Units shipped empty.

Operation: The unique misting nozzle provides safety from electrical shock, making this extinguisher ideal for use in telecommunications and cleanroom environments.

Construction: Non-magnetic cylinder and misting nozzle. For use in medical facilities.

GRENADIER EXTINGUISHERS: PRESSURIZED WATER

CLASS A FIRES



The "water press" extinguisher contains water and compressed air. Units shipped empty.

Operation: Squeeze the lever, which opens the valve, allowing the water to be forced out. Upright squeeze grip.

Construction: Butt-welded 304-L stainless steel cylinder. Heavy-duty, brass, chrome-plated valve body with replaceable molded valve stem seal.



ORBIT LOW PROFILE EXTINGUISHERS: MULTI-PURPOSE ABC OR PURPLE K

Available for wall mount in both Multi-Purpose ABC or Purple K (FE10VB & FPK10VB) or available in cabinet mount version with Multi-Purpose ABC (FE10V). See JL's low profile 2100 series cabinet on pg. 11.

Operation: Squeeze the lever, which opens the valve, allowing the chemical to be forced out. Temperature range from -40°F to +120°F.

Construction: Corrosion resistant, powder coated, tempered aluminum vessel with aluminum valve and siphon tube. Visual pressure gauge, stainless steel pull pin, handles, bracket and button hook.



WHEELED EXTINGUISHERS: MULTI-PURPOSE AND REGULAR DRY CHEMICAL

Available in three size capacities with two choices of extinguishing agent and three different operational design configurations, the best match for your hazard protection needs can be accurately selected, maximizing the fire safety of your operation. Easily transportable through doorways and over rough terrain.

Typical Uses: Offshore rigs, ship docks, refineries, chemical plants, aircraft ramps, processing plants, storage and loading areas.

Construction: Cylinders with chrome-plated brass valve assemblies manufactured to DOT specification 4BW240. Highly visible pressure-indicating gauge. Cylinders and carriages are shot blasted, primed and coated with powder coat finish that exceeds Underwriter's Laboratories 240 hour salt spray requirements. All units are equipped with all weather semi-pneumatic 12.3 inch diameter, 3.5 inch wide tires that allows for easy movability through narrow doors and walkways by a single operator. Built to ANSI/UL 299 and 711 standards.

Other Extinguishant Types: Carbon Dioxide and Halotron™ wheeled units also available. See website for more information.



MODEL	NOMINAL CAPACITY	SHIPPING WEIGHT	CYLINDER DIAMETER	OVERALL HEIGHT	OVERALL WIDTH	SHIPPING VOLUME	U/L RATING	OPTIONAL MOUNTING BRACKET	US COAST GUARD APPROVED
Grenadier-P	2-½ gal.	7-¾ lbs.	7"	24-½"	9	1.1 cu.ft.	2A	MB810	YES
Cosmic 2-½E*	2-½ lbs.	5-½ lbs.	3-¾"	15-½"	5-¾"	.2 cu.ft.	1-A:10-B:C	MB817C or MB817A*	YES
Cosmic 5E	5 lbs.	10 lbs.	4-¼"	16-¾"	7-¼"	.35 cu.ft.	3-A:40-B:C	MB818C or MB818A	
Cosmic 6E	6 lbs.	12-¾ lbs.	5"	16"	7-¾"	.5 cu.ft.	3-A:40-B:C	MB808A	
Cosmic 10E	10 lbs.	18-¼ lbs.	5-½"	21"	7-¾"	.65 cu.ft.	4-A:80-B:C	MB846C or MB846A	
Cosmic 20E (FE20C)	20 lbs.	33-½ lbs.	7-½"	21-¼"	8-¾"	1.0 cu.ft.	10-A:120-B:C	MB811C	
Cosmic 20E (FE20A)	20 lbs.	38 lbs.	7"	24"	10-¼"	1.0 cu.ft.	10-A:120-B:C	MB810A	
Sentinel 5	5 lbs.	14 lbs.	5-¼"	17-¾"	8-¼"	.65 cu.ft.	5-B:C	MB809C or MB809A	YES
Sentinel 10	10 lbs.	28-¼ lbs.	7"	24"	12"	1.3 cu.ft.	10-B:C	MB810C or MB810A	
Sentinel 15	15 lbs.	37-¾ lbs.	7"	30"	12"	1.0 cu.ft.	10-B:C	MB810C or MB864A	
Sentinel 20	20 lbs.	50-¾ lbs.	8"	30"	13"	2.1 cu.ft.	10-B:C	MB811C or MB811A	
Galaxy 2-½*	2-½ lbs.	5-½ lbs.	3-¾"	15-½"	5-¾"	.2 cu.ft.	10-B:C	MB817C	YES
Galaxy 5-½	5-½ lbs.	10-½ lbs.	4-¼"	16-¾"	7-¼"	.4 cu.ft.	40-B:C	MB818C	
Galaxy 10	10 lbs.	18-¼ lbs.	5-½"	21"	7-¾"	.65 cu.ft.	40-B:C	MB846C	
Galaxy 20	20 lbs.	38 lbs.	7-½"	23-¼"	10-¼"	1.0 cu.ft.	120-B:C	MB811C	
Mercury 2-½*	2-½ lbs.	5-¼ lbs.	3-¾"	15-½"	6-¾"	.25 cu.ft.	2-B:C	MB817C or MB817A*	N/A
Mercury 5*	5 lbs.	9-½ lbs.	4-¼"	16-¾"	7-¼"	.3 cu.ft.	5-B:C	MB818C or MB818A	YES
Mercury 11 (FM11C)	11 lbs.	21-¼ lbs.	7"	17-½"	8-¾"	1.0 cu.ft.	1-A:10-B:C	MB810C	
Mercury 11 (FM11A)	11 lbs.	22-½ lbs.	6"	21-¾"	9-¼"	1.0 cu.ft.	1-A:10-B:C	MB812A	
Mercury 15-½ (FM15C)	15-½ lbs.	25-¾ lbs.	7"	17-½"	8-¾"	1.0 cu.ft.	2-A:10-B:C	MB810C	
Mercury 15-½ (FM15A)	15-½ lbs.	27-½ lbs.	6"	21-7/8"	9-¼"	1.0 cu.ft.	2-A:10-B:C	MB812A	
Saturn 15	1.8 gal.	22-½ lbs.	7"	19-¼"	9"	.9 cu.ft.	1-A:K or 2-A:K	MB810C or MB810A	-
Saturn 25	2.5 gal.	33-½ lbs.	7"	24-½"	9"	1.1 cu.ft.			
Nebula 270	1-¾ gal.	7 lbs.	7"	24-½"	11"	1.1 cu. ft.	2-A:C	MB810NM	-
Nebula 272	2-½ gal.	8 lbs.	7"	27-½"	11"	1.3 cu ft.		MB810NM	
Nebula 250	2-½ gal.	8.3 lbs.	7"	28"	14"	1.3 cu ft.		-	
Orbit ABC 10 (FE10V)*	10 lbs.	28-½ lbs.	3" x 10"	22"	11"		4-A:80-B:C	Button Hook Incl. for Wall/Cabinet	-
Orbit ABC 10 (FE10VB)	10 lbs.	26-½ lbs.	3-½" x 8"	23"	9"		4-A:80-B:C	Wall Mount Button Hook Incl.	
Orbit Purple K 10 (FPK10VB)	10 lbs.	26.6 lbs.	3-½" x 8"	23"	9"		80-B:C	Wall Mount Button Hook Incl.	

*Indicates mounting bracket standard. J Hook wall bracket standard with all other extinguishers.

NOTE: JL Extinguishers are shipped fully charged with the exception of the Grenadier & Nebula. NFPA regulations also require extinguishers to be inspected when initially placed in service and all local fire code and all local fire code and tagging requirements must be adhered to. All fire extinguisher sizes are nominal. Contact customer service for more information about ordering tagged extinguishers in your area.



ARCHITECTURAL SERIES

THESE FOUR POPULAR ARCHITECTURAL SERIES FEATURE MULTIPLE DOOR STYLES, GLAZING OPTIONS AND MATERIALS.

Trim Style and Depth Options:

- Trimless Recessed - for 5/8" depth drywall or 3/4" plaster
- Recessed - 3/8" flat trim
- Semi-recessed - 1-1/4", 1-1/2" square edge or 2-1/2", 3", 4", 4-1/2" rolled edge
- Surface-mount square edge
- Surface mount rolled edge upon request



1017F10 with Optional Lettering and Black Painted



1013F10



1027V10 Dark Bronze



1027V10



1036F16 with Optional Polished #7



1035S21



1036C70 with Optional Cosmic 10E



1012P48A Flush Pull standard

AMBASSADOR SERIES: STEEL

FIRE-FX-2 UP TO 2 HR

PRODUCT DETAILS:

Trim & Door Material: Door and square edge trim styles - 20 gauge cold rolled steel. Rolled edge trim styles - 18 gauge.

Tub Material: Cold rolled steel

Finish: White powder coat

ADDITIONAL OPTIONS

Powder Coat Finishes: Several other colors to select from

ACADEMY SERIES: ALUMINUM

FIRE-FX-2 UP TO 2 HR

PRODUCT DETAILS:

Trim & Door Material: .040" or .050 or .070 trim aluminum .040 gauge door

Tub Material: White powder coated cold rolled steel. Surface mount models are clear anodized aluminum.

Door & Trim Finish: Clear anodized

ADDITIONAL OPTIONS

Optional Materials: .040" aluminum Tub (Non-Rated Use)

Optional Finishes: .050" Dark Bronze Anodized

COSMOPOLITAN SERIES: STAINLESS STEEL

FIRE-FX-2 UP TO 2 HR

PRODUCT DETAILS:

Trim & Door Material: Door and square edge trim styles - 20 gauge 304 stainless steel. Rolled edge trim styles - 18 gauge 304 stainless.

Tub Material: White powder coated cold rolled steel. Surface mount models have 304 stainless sides and back.

Door & Trim Finish: #4 stainless

ADDITIONAL OPTIONS

Optional Finishes: #6, #7, #8 stainless

PANORAMA SERIES: FRAMELESS ACRYLIC DOOR

FIRE-FX-2 UP TO 2 HR

PRODUCT DETAILS:

A frameless door of clear polycarbonate textured acrylic. Textured models available in 3 background colors with choice of lettering. This cabinet gives you the same construction as the Ambassador, Academy and Cosmopolitan cabinets with a completely different door look. Select from clear, black, white, or red acrylic door with contrasting lettering in a range of trim styles.

Trim Material: Cold rolled steel, stainless steel, aluminum

Tub Material: White powder coated cold rolled steel. Tub of stainless steel and aluminum surface mount models are same material as trim. See above models for details.

SEE PAGE 8 FOR DIAGRAM OF CABINET DIMENSIONS AND EXAMPLE OF PROFILES
SEE PAGE 14 TO VIEW DOOR STYLES



AMBASSADOR, ACADEMY, COSMOPOLITAN AND PANORAMA

COMPATIBLE EXTINGUISHERS	STEEL	ALUMINUM	STAINLESS STEEL	TRIM STYLE	TUB I.D.			FRAME O.D.		WALL OPENING: NON-RATED [FIRE-RATED]			
					A (W)	B (H)	C (D)	E	F	WIDTH	HEIGHT	DEPTH	
Cosmic 2.5-6 Galaxy 2.5-5 Mercury 2.5-5 <i>(Mount 6lb to tub)</i>	8114W	8124W [†]	8134W [†]	Trimless 5/8" Drywall‡				-	-			5-5/8" [6-3/16"]	
	8115	8125	8135	3/8" Flat Trim	9"	18"	5-1/2"	12-3/8"	21-3/8"	10"	19"	5-3/8" [6-7/16"]	
	8116	8126	8136	1-1/2" Square								4-1/8" [5-3/16"]	
	8117	8127	8137	2-1/2" Rolled								3-1/8" ** [4"]*	
	8113	8123	8133	Surface Mount Sq.	12-3/16"	21-3/16"	6"			-	-	-	
Cosmic 2.5-5 Galaxy 2.5-5.5 Mercury 2.5 & 5	1710 [†]	1720 [†]	1730 [†]	2-1/4" Square			5"					3" [4"]	
	Cosmic 2.5-6 Galaxy 2.5-5 Mercury 2.5-5 <i>(Mount 6lb to tub)</i>	1815	1825	1835	3/8" Flat Trim	10-1/2"	24"	5-1/2"	13-7/8"	27-3/8"	11-1/2"	25"	5-3/8" [6-7/16"]
		1816	1826	1836	1-1/2" Square								4-1/8" [5-3/16"]
		1817	1827	1837	3" Rolled								2-5/8" [3-1/16"]
		1812	1822	1832	4" Rolled, Flush Pull								1-7/8" ** [2-7/16"]*
1818	1828	1838	4-1/2" Rolled								1-1/8" ** [2-3/16"]*		
Cosmic 2.5-10 Galaxy 2.5-10 Mercury 2.5-5 Sentinel 5	1014W	1024W [†]	1034W [†]	Trimless 5/8" Drywall‡				-	-			6-1/8" [6-1/16"]	
	1015	1025	1035	3/8" Flat Trim	10-1/2"	24"	6"	13-7/8"	27-3/8"	11-1/2"	25"	5-7/8" [6-1/16"]	
	1016	1026	1036	1-1/2" Square								4-5/8" [5-1/16"]	
	1017	1027	1037	3" Rolled								3-1/8" [4"]	
	1012	1022	1032	4" Rolled, Flush Pull								2-3/8" ** [3-3/16"]*	
	1018	1028	1038	4-1/2" Rolled								1-5/8" ** [2-1/16"]*	
	1013	1023	1033	Surface Mount Sq.	13-11/16"	27-3/16"	6-1/2"			-	-	-	
Any Cosmic** Any Galaxy** Any Mercury Any Saturn Grenadier P Sentinel 5-10 Nebula 270	2014W	2024W [†]	2034W [†]	Trimless 5/8" Drywall‡				-	-			7-7/8" [8-7/16"]	
	2015	2025	2035	3/8" Flat Trim	12"	27"	7-3/4"	15-3/8"	30-3/8"	13"	28"	7-5/8" [8-1/16"]	
	2016	2026	2036	1-1/4" Square								6-5/8" [7-1/16"]	
	2017	2027	2037	2-1/2" Rolled								5-3/8" ** [6-7/16"]*	
	2012	2022	2032	4" Rolled, Flush Pull								4-1/8" ** [5-1/8"]*	
	2018	2028	2038	4-1/2" Rolled								3-3/8" ** [4-7/16"]*	
	2013	2023	2033	Surface Mount Sq.	15-3/16"	30-3/16"	8-1/4"			-	-	-	
Any Cosmic** Any Galaxy** Any Mercury Any Saturn Grenadier P Sentinel 5-15 Nebula 250, 270, 272	3015	3025	3035	3/8" Flat Trim	16"	32"	7-3/4"	19-3/8"	35-3/8"	17"	33"	7-5/8" [8-1/16"]	
	3016	3026	3036	1-1/4" Square								6-5/8" [7-1/16"]	
	3017	3027	3037	2-1/2" Rolled								5-3/8" ** [6-7/16"]*	
	3012	3022	3032	4" Rolled, Flush Pull								4-1/8" ** [5-1/8"]*	
	3018	3028	3038	4-1/2" Rolled								3-3/8" ** [4-7/16"]*	
	3013	3023	3033	Surface Mount Sq.	19-3/16"	35-3/16"	8-1/4"			-	-	-	
(2) Any Cosmic** (2) Any Galaxy** (2) Any Mercury (2) Any Saturn (2) Grenadier P (2) Sentinel 5	4015	4025	4035	3/8" Flat Trim	20"	27"	7-3/4"	23-3/8"	30-3/8"	21"	28"	7-5/8" [8-1/16"]	
	4016	4026	4036	1-1/4" Square								6-5/8" [7-1/16"]	
	4017	4027	4037	2-1/2" Rolled								5-3/8" ** [6-7/16"]*	
	4012	4022	4032	4" Rolled, Flush Pull								4-1/8" ** [5-1/8"]*	
	4018	4028	4038	4-1/2" Rolled								3-3/8" ** [4-7/16"]*	
	4013	4023	4033	Surface Mount Sq.	23-3/16"	30-3/16"	8-1/4"			-	-	-	

*Add 5/8" wall depth for cabinets with aluminum frames. **Cosmic 20 & Galaxy 20 extinguisher must be mounted on the back of the cabinet tub.
[†] Panorama Style Doors Not Available [‡] Trimless models may be installed before drywall - See submittal and installation instructions for more information.



ARCHITECTURAL SERIES

CAVALIER SERIES: DECORATIVE BRONZE OR BRASS



1085V10
US10B Oil Rubbed
Bronze

1045V10
US10 Satin
Bronze

PRODUCT DETAILS:

Select the beauty and lustrous finishes of bronze or brass to add that upscale look to your next project

Trim & Door Material: Bronze or brass

Trim & Door Finish: US10 Satin bronze, US10B oil-rubbed bronze or US3 polished brass

Tube Material: Cold rolled steel with white powder coat. Surface mount models match trim material.

Door Pulls: Material matches finish

ADDITIONAL OPTIONS

Trim & Door Material: US9 - Bright Polished Bronze, US4 - Satin Brass

CLEAR VU SERIES: ACRYLIC BUBBLE



1535G25

1515F25

PRODUCT DETAILS:

An attractive bubble cabinet for one or two fire extinguishers with five material options to match the decor

Trim & Door Material: Cold rolled steel, 304 stainless steel, aluminum, bronze or brass

Finish: White powder coat, #4 stainless, clear anodized aluminum, US10 satin bronze or US3 polished brass

Bubble: Acrylic bubble allows 180° extinguisher visibility. 2-1/2" projection for 1500 Series, 3-1/2" projection for 2500 and 4500 Series.

Tube: Constructed of cold rolled steel with white powder coat finish. Surface mount cabinets match trim material. Extinguisher must be mounted to back of tub using J-hook.

ADDITIONAL OPTIONS

Trim & Door Material: US9 - Bright Polished Bronze, US4 - Satin Brass, Dark Anodized Aluminum, or #6, #7, #8 Stainless Steel

CABINET PROFILES - AMBASSADOR, ACADEMY, COSMOPOLITAN, PANORAMA, CAVALIER

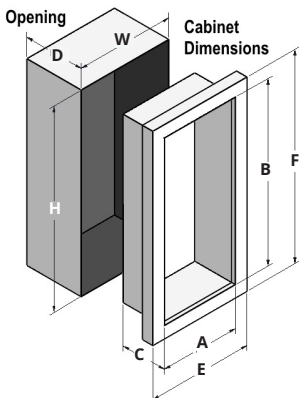
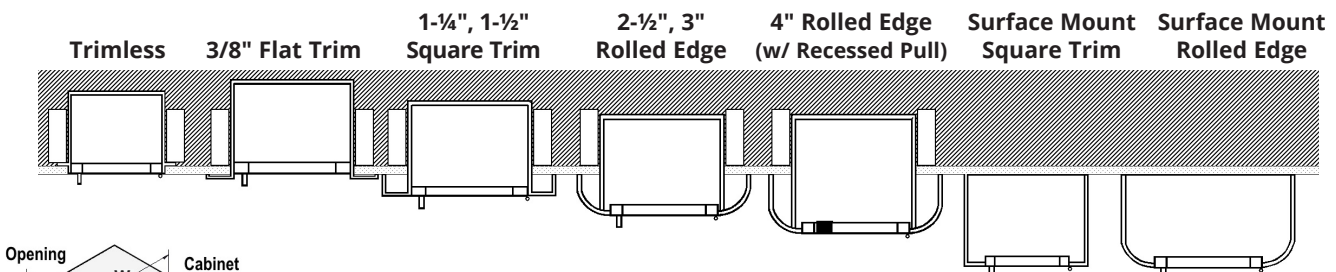

Recessed Pull
w/SAF-T-LOK™



Door Styles
w/SAF-T-LOK™

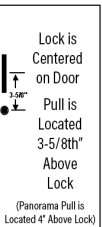

Door Styles
w/No Lock

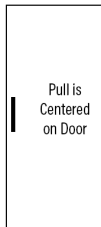

CABINET PROFILES - CLEAR VU

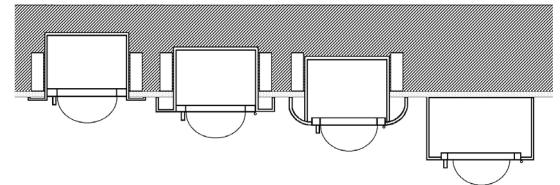

3/8"
Flat
Trim

1-1/4",
1-1/2"
Square
Trim

2-1/2", 3"
Rolled
Edge

Surface
Mount
Square Trim



CAVALIER

COMPATIBLE EXTINGUISHERS	US10 SATIN BRONZE	US10B OIL-RUBBED BRONZE	US3 POLISHED BRASS	TRIM STYLE	TUB I.D.			FRAME O.D.		WALL OPENING: NON-RATED [FIRE-RATED]				
					A (W)	B (H)	C (D)	E	F	WIDTH	HEIGHT	DEPTH		
					Cosmic 2.5-6 Galaxy 2.5-5 Mercury 2.5-5 <i>(Mount 6lb to tub)</i>	1845	1885	1855	3/8" Flat Trim					
	1846	1886	1856	1-1/2" Square	10-1/2"	24"	5-1/2"	13-7/8"	27-3/8"	11-1/2" [12-13/16"]	25 [26-5/16"]	5-3/8" [6-7/16"]	4-1/8" [5-3/16"]	2-5/8" [3-5/8"]
	1847	1887	1857	3" Rolled										
Cosmic 2.5-10 Galaxy 2.5-10 Mercury 2.5-5 Sentinel 5	1045	1085	1055	3/8" Flat Trim										
	1046	1086	1056	1-1/2" Square	10-1/2"	24"	6	13-7/8"	27-3/8"	11-1/2" [12-13/16"]	25 [26-5/16"]	5-7/8" [6-15/16"]	4-5/8" [5-11/16"]	3-1/8" [4"]
	1047	1087	1057	3" Rolled										
	1043	1083	1053	Surface Mount	13-11/16"	27-3/16"	6-1/2"			-	-	-	-	-
Any Cosmic* Any Galaxy Any Mercury Any Saturn Grenadier P Sentinel 5-10	2045	2085	2055	3/8" Flat Trim*										
	2046	2086	2056	1-1/4" Square*	12	27	7-3/4"	15-3/8"	30-3/8"	13 [14-5/16"]	28 [29-5/16"]	7-5/8" [8-11/16"]	6-5/8" [7-11/16"]	-
	2043	2083	2053	Surface Mount	15-3/16"	30-3/16"	8-1/4"	15-3/8"	30-3/8"	-	-	-	-	-

*Cosmic 20 & Galaxy 20 extinguisher must be mounted on the back of the cabinet tub.

CLEAR VU

COMPATIBLE EXTINGUISHERS	STEEL	ALUMINUM*	STAINLESS STEEL	US10 SATIN BRONZE	US3 POLISHED BRASS	TRIM STYLE	TUB I.D.			FRAME O.D.		WALL OPENING: NON-RATED [FIRE-RATED]				
							A (W)	B (H)	C (D)	E	F	WIDTH	HEIGHT	DEPTH		
							Cosmic 2.5-10 Galaxy 2.5-10 Mercury 2.5-5 Sentinel 5	1515	1525	1535	1545	1555	Flat Trim			
	1516	1526	1536	1546	1556	1-1/2" Square	10-1/2"	24"	4"	13-7/8"	27-3/8"	11-1/2" [12-13/16"]	25" [26-5/16"]	3-7/8" [4-15/16"]	2-5/8" [3-11/16"]	1-1/8" [2-3/16"]
	1517	1527	1537	1547	1557	3" Rolled										
	1513	1523	1533	1543	1553	Surf. Mtd.	13-11/16"	27-3/16"	4-1/2"	13-7/8"	27-3/8"	-	-	-	-	
Cosmic 2.5-10, 20A Galaxy 2.5-10 Mercury 2.5-11A, 15A Sentinel 5 Saturn 15-25 Grenadier P Nebula 270, 272	2515	2525	2535	2545	2555	Flat Trim										
	2516	2526	2536	2546	2556	1-1/4" Square	14"	30"	4"	17-3/8"	33-3/8"	15" [16-5/16"]	31" [32-5/16"]	3-7/8" [4-15/16"]	2-7/8" [3-15/16"]	1-5/8"* [2-11/16"]*
	2517	2527*	2537	-	-	2-1/2" Rolled										
	2513	2523	2533	2543	2553	Surf. Mtd.	17-3/16"	33-3/16"	4-1/2"	17-3/8"	33-3/8"	-	-	-	-	
(2) Cosmic 2.5-10 (2) Galaxy 2.5-10 (2) Mercury 2.5-11A, 15A (2) Sentinel 5 (2) Grenadier P Nebula 270, 272	4515	4525	4535	-	-	Flat Trim Double Door	28"	30"	4"	31-3/8"	33-3/8"	29"	31"	3-7/8"		
	4513	4523	4533	-	-	Surf. Mtd. Double Door	31-3/16"	33-3/16"	4-1/2"	31-3/8"	33-3/8"	-	-	-		

*Add 5/8" to wall depth for a cabinet with an aluminum frame. 4500 series consist of a double door design.



Cavalier
1057F10
US3 Polished Brass



Cavalier
1076V15
US4 Brass



Clear Vu - 1535G27, 1527F25, 1513F25, 1535G26



ARCHITECTURAL SERIES



EMBASSY SERIES: DECORATIVE TRIMLESS RECESSED

 FIRE-FX-2 UP TO 2 HR

PRODUCT DETAILS:

Recessed Embassy cabinets are always ADA-compliant; are offered in five attractive materials and several door styles. Embassy cabinets are available for fire extinguishers and valve and hose cabinets.

Door Construction: These 7/8" formed design cabinet doors are available cold rolled steel, 304 stainless steel, aluminum, brass or bronze. Doors feature two concealed hinges, concealed handle and roller catch.

Door Finish: White powder coat finish, stainless steel #4, clear anodized aluminum, US10 satin bronze, or US3 polished brass. Doors with lock have handle located above lock on the face of the cabinet.

Tub: Constructed of cold rolled steel with white powder coat finish

Options at Additional Cost: U10B oil-rubbed bronze



ORBIT SERIES: LOW PROFILE FOR ORBIT EXTINGUISHERS

 FIRE-FX-2 UP TO 2 HR

PRODUCT DETAILS:

Trim & Door Finish: White powder coat finish, stainless steel #4, clear anodized aluminum, US10 satin bronze, or US3 polished brass

Tub: Constructed of cold rolled steel with white powder coat finish. Tub fits only the Orbit model FE10V extinguisher.

Options at Additional Cost: U10B oil-rubbed bronze



ROYAL SERIES: FIRE BLANKET / CABINET

 FIRE FX-2 ON THE 3600 SERIES

PRODUCT DETAILS:

3600 Combination Extinguisher & Blanket Cabinet: Door & trim choices for steel, anodized aluminum or 304 stainless steel #4 finish with ten door styles to choose from. Five recessed cabinet configurations and a surface mount version provide plenty of installation options. Includes shelf for blanket and flush cabinet door with continuous hinge, zinc plated pull and roller catch. Door options include full glazing, vertical duo or solid door. Cabinet also available fire-rated.

Roller Blanket Cabinet: Model C9519S21 is a steel roller-type cabinet for emergency use. The enclosed blanket is attached to the vertical roller and comes with arm loops to enable a person to wrap themselves in the blanket in one continuous motion.

Drop Blanket Cabinet: Model C9613S21 is a handy "drop" type steel cabinet with a folded blanket. Handle is pulled down to open the bottom mounted door, which then releases the blanket.

Blanket: Nominal 26" x 80", 2.75 lb, processed wool/synthetic fire blanket which meets the Flammable Fabrics Act: Title 16, CFR 1610



EMBASSY

COMPATIBLE EXTINGUISHERS FD VALVES & HOSE RACKS	STEEL	ALUMINUM	STAINLESS STEEL	US10 SATIN BRONZE	US3 POLISHED BRASS	TUB I.D.			DOOR O.D.		WALL OPENING: NON-RATED [FIRE-RATED]		
						A (W)	B (H)	C (D)	E	F	WIDTH	HEIGHT	DEPTH
						Cosmic 2.5-10 Galaxy 2.5-10 Mercury 2.5-5 Sentinel 5	5614	5624	5634	5644	5654	10-1/2"	24"
Any Cosmic** Any Galaxy** Any Mercury Any Saturn Grenadier P Sentinel 5-15 Nebula 250 270 272	5714	5724	5734	5744	5754	16"	32"	7-3/4"	18-1/4" [19-1/4"]	34-1/4" [35-1/4"]	17" [18-3/16"]	33" [34-3/16"]	7-7/8" [8-15/16"]
FIRE DEPARTMENT VALVE, HOSE & EXTINGUISHER CABINETS													
1-1/2" or 2-1/2" Fire Dept Valve Left & right K.O.'s centered one on each side or 9" from top, 4" from bottom & back. †	5514	5524	5534	5544	5554	18"	18"	7-3/4"	20-1/4" [21-1/4"]	20-1/4" [21-1/4"]	19" [20-5/16"]	19" [20-5/16"]	7-7/8" [8-15/16"]
1-1/2" or 2-1/2" Rack Unit & 2-1/2" Fire Dept Valve or Extinguisher**. 2 left side K.O.'s 4" from back, top & bottom. †	5814	5824	5834	-	-	32"	32"	7-3/4"	34-1/4" [35-1/4"]	34-1/4" [35-1/4"]	33" [34-5/16"]	33" [34-5/16"]	7-7/8" [8-15/16"]
2-1/2" Fire Department Valve Any Cosmic, Galaxy, Mercury, Saturn Grenadier P Sentinel 5 & 10 Nebula 270 Left & right K.O.'s 4" from bottom. †	5914	5924	5934	5944	5954	16"	40"	8-3/4"	18-1/4" [19-1/4"]	42-1/4" [43-1/4"]	17" [18-3/16"]	41" [42-3/16"]	8-7/8" [9-15/16"]

**Cosmic 20 & Galaxy 20 extinguisher must be mounted on the back of the cabinet tub.

† Knockouts not available on Fire-Rated Cabinets

ORBIT

COMPATIBLE EXTINGUISHERS	STEEL	ALUMINUM	STAINLESS STEEL	US10 SATIN BRONZE	US3 POLISHED BRASS	TRIM STYLE	TUB I.D.			FRAME O.D.		WALL OPENING: NON-RATED [FIRE-RATED]		
							W	H	D	E	F	W	H	D
							Orbit FE10V	2115	2125	2135	2145	2155	3/8" Flat Trim	12"
	2119	-	2139	-	-	Surface Mount, Flush Pull	15-1/4"	30-1/4"	3-11/16"	15-3/8"	30-3/8"	-	-	-

ROYAL 3600 SERIES

COMPATIBLE EXTINGUISHERS	STEEL	ALUMINUM	STAINLESS	TRIM STYLE	TUB I.D.			FRAME O.D.		WALL OPENING: NON-RATED [FIRE-RATED]			
					W	H	D	E	F	W	H	D	
					Cosmic 2.5-10 Galaxy 2.5-10 Mercury 2.5-15(FM11C & 15C)	3615	3625	3635	Flat Trim				
	3616	3626	3636	1-1/2" Square									6-7/8" [7-15/16"]
	3617	3627*	3637	2-1/2" Rolled	12"	36"	8"	15-3/8"	39-3/8"	13" [14-5/16"]	37" [38-5/16"]		5-5/8" [6-11/16"]*
Sentinel 5-10, Saturn 15-25, Nebula 270	3612	3622*	3632	4" Rolled, Flush Pull									4-3/8" [5-3/8"]*
Grenadier P	3618	3628*	3638	4-1/2" Rolled									3-5/8" [4-11/16"]*
	3613	3623	3633	Surface Mounted	15-3/16"	39-3/16"	8-1/2"	15-3/8"	39-3/8"	-	-	-	-

*Add 5/8" wall depth for cabinets with aluminum frames.



ARCHITECTURAL SERIES



8515F10

CROWLINE 6000-7200: FIRE HOSES AND EXTINGUISHERS



FIRE-FX-2 UP TO 2 HR

PRODUCT DETAILS:

Trim & Door Material: Cold rolled steel, 304 stainless steel or aluminum

Finish: White powder coat, #4 stainless, clear anodized aluminum

Tube: White powder coated cold rolled steel. Surface mount models are same material as door & trim.

Trim Style and Depth: Rolled edge aluminum trim is formed of extrusions. Surface mount steel and aluminum have square edge, stainless models have rolled edge.

RECOMMENDED HOSE RACK, VALVE, AND EXTINGUISHERS	STEEL	ALUMINUM	STAINLESS STEEL	TRIM STYLE	TUB I.D.			FRAME O.D.		WALL OPENING: NON-RATED [FIRE-RATED]		
					A (W)	B (H)	C (D)	E	F	WIDTH	HEIGHT	DEPTH
50' or 75' - 1-1/2" x 1-1/2" HOSE RACK HRA050B or HRA050CH HRA075B or HRA075CH EXTINGUISHER: Cosmic 2-1/2 Galaxy 2-1/2 - 5lb	6014W	6024W	6034W	Trimless 5/8" Drywall†				-	-			6-1/8" [6-1/16"]
	6015	6025	6035	Flat Trim	24"	30"	6"			25"	31"	5-7/8" [6-15/16"]
	6016	6026	6036	1-1/4" Square				27-3/8"	33-3/8"	[26-5/16"]	[32-5/16"]	4-7/8" [5-15/16"]
	6017	6027	6037	2-1/2" Rolled								3-5/8" [4-1/16"]*
	6013	6023	6039**	Surface Mount	27-3/16"	33-3/16"	6-1/2"					-
50' or 75' - 2-1/2" x 1-1/2" HOSE RACK: H4A050B-2.5 HRA075B-2.5	6114W	6124W	6134W	Trimless 5/8" Drywall†				-	-			8-1/8" [8-1/16"]
	6115	6125	6135	Flat Trim	24"	30"	8"			25"	31"	7-7/8" [8-15/16"]
	6116	6126	6136	1-1/4" Square				27-3/8"	33-3/8"	[26-5/16"]	[32-5/16"]	6-7/8" [7-15/16"]
	6117	6127	6137	2-1/2" Rolled								5-5/8" [6-1/16"]*
	6113	6123	6139**	Surface Mount	27-3/16"	33-3/16"	8-1/2"					-
100' - 1-1/2" x 1-1/2" HOSE RACK: HRA100B HRA100CH EXTINGUISHER: Cosmic 2-1/2 Galaxy 2-1/2 - 5lb	6214W	6224W	6234W	Trimless 5/8" Drywall†				-	-			6-1/8" [6-1/16"]
	6215	6225	6235	Flat Trim	24"	34-3/4"	6"			25"	35-3/4"	5-7/8" [6-15/16"]
	6216	6226	6236	1-1/4" Square				27-3/8"	38-1/8"	[26-5/16"]	[37-1/16"]	4-7/8" [5-15/16"]
	6217	6227	6237	2-1/2" Rolled								3-5/8" [4-1/16"]*
	6213	6223	6239**	Surface Mount	27-3/16"	37-15/16"	6-1/2"					-
100' - 2-1/2" x 1-1/2" HOSE RACK: HRA 100B-2.5	6414W	6424W	6434W	Trimless 5/8" Drywall†				-	-			8-1/8" [8-1/16"]
	6415	6425	6435	Flat Trim	24"	34-3/4"	8"			25"	35-3/4"	7-7/8" [8-15/16"]
	6416	6426	6436	1-1/4" Square				27-3/8"	38-1/8"	[26-5/16"]	[37-1/16"]	6-7/8" [7-15/16"]
	6417	6427	6437	2-1/2" Rolled								5-5/8" [6-1/16"]*
	6413	6423	6439**	Surface Mount	27-3/16"	37-15/16"	8-1/2"					-
125' - 2-1/2" x 1-1/2" HOSE RACK: HRA 125B-2.5	6614W	6624W	6634W	Trimless 5/8" Drywall†				-	-			8-1/8" [8-1/16"]
	6615	6625	6635	Flat Trim	24"	38-3/4"	8"			25"	39-3/4"	7-7/8" [8-15/16"]
	6616	6626	6636	1-1/4" Square				27-3/8"	42-1/8"	[26-5/16"]	[41-1/16"]	6-7/8" [7-15/16"]
	6617	6627	6637	2-1/2" Rolled								5-5/8" [6-1/16"]*
	6613	6623	6639**	Surface Mount	27-3/16"	41-15/16"	8-1/2"					-
50' or 75' - 2-1/2" x 1-1/2" HOSE RACK: FD VALVE 1-1/2" OR 2-1/2" Valve OR EXTINGUISHER: Any Extinguisher (Except Sentinel 10-20, Nebula 272)	6314W	6324W	6334W	Trimless 5/8" Drywall†				-	-			8-1/8" [8-1/16"]
	6315	6325	6335	Flat Trim	30"	30"	8"			31"	31"	7-7/8" [8-15/16"]
	6316	6326	6336	1-1/4" Square				33-3/8"	33-3/8"	[32-5/16"]	[32-5/16"]	6-7/8" [7-15/16"]
	6317	6327	6337	2-1/2" Rolled								5-5/8" [6-1/16"]*
	6313	6323	6339**	Surface Mount	33-3/16"	33-3/16"	8-1/2"					-
HOSE RACK & FD VALVE OR EXTINGUISHER: 1-1/2" OR 2-1/2" Valve, 100' Hose Rack Unit Plus FD Valve or Extinguisher (Not Sentinel 20, Nebula 272)	6514W	6524W	6534W	Trimless 5/8" Drywall†				-	-			8-1/8" [8-1/16"]
	6515	6525	6535	Flat Trim	32-3/4"	34-3/4"	8"			33-3/4"	35-3/4"	7-7/8" [8-15/16"]
	6516	6526	6536	1-1/4" Square				36-1/8"	38-1/8"	[35-1/16"]	[37-1/16"]	6-7/8" [7-15/16"]
	6517	6527	6537	2-1/2" Rolled								5-5/8" [6-1/16"]*
	6513	6523	6539**	Surface Mount	35-15/16"	37-15/16"	8-1/2"					-
HOSE RACK & FD VALVE OR EXTINGUISHER: 1-1/2" OR 2-1/2" Valve, 125' Hose Rack Unit Plus FD Valve or Extinguisher (Not Sentinel 20, Nebula 272)	7214W	7224W	7234W	Trimless 5/8" Drywall†				-	-			8-1/8" [8-1/16"]
	7215	7225	7235	Flat Trim	32-3/4"	38-3/4"	8"			33-3/4"	39-3/4"	7-7/8" [8-15/16"]
	7216	7226	7236	1-1/4" Square				36-1/8"	42-1/8"	[35-1/16"]	[41-1/16"]	6-7/8" [7-15/16"]
	7217	7227	7237	2-1/2" Rolled								5-5/8" [6-1/16"]*
	7213	7223	7239**	Surface Mount	35-15/16"	41-15/16"	8-1/2"					-

*Add 5/8" wall depth for cabinets with aluminum frames. ‡ Trimless models may be installed before drywall. ** Rolled edge
See submittal and installation instructions for more information and knockout locations.



CROWNLINE 8000 SERIES: FIRE DEPARTMENT VALVE

FIRE-FX-2 UP TO 2 HR

PRODUCT DETAILS:

Trim & Door Material: Cold rolled steel, 304 stainless steel or aluminum

Finish: White powder coat, #4 stainless, clear anodized aluminum

Tub: White powder coated cold rolled steel. Surface mount models are same material as door & trim.

Trim Style and Depth: Rolled edge aluminum trim is formed of extrusions. Surface mount steel and aluminum have square edge, stainless models have rolled edge.



8516V10

RECOMMENDED HOSE RACK, VALVE, AND EXTINGUISHERS	STEEL	ALUMINUM	STAINLESS STEEL	TRIM STYLE	TUB I.D.			FRAME O.D.		WALL OPENING: NON-RATED [FIRE-RATED]			
					A (W)	B (H)	C (D)	E	F	WIDTH	HEIGHT	DEPTH	
FIRE DEPARTMENT VALVE 1-½" or 2-½" Fire Department Valve with Cap and Chain	8514W	8524W	8534W	Trimless 5/8" Drywall [‡]				-	-			8-½"	[8-½"]
	8515	8525	8535	Flat Trim	18"	18"	8"			19"	19"	7-7/8"	[8-15/16"]
	8516	8526	8536	1-¼" Square				21-3/8"	21-3/8"	[20-5/16"]	[20-5/16"]	6-7/8"	[7-15/16"]
	8517	8527	8537	2-½" Rolled								5-5/8"	[6-11/16"] [‡]
	8513	8523	8539**	Surface Mount	21-3/16"	21-3/16"	8-½"					-	-
	8414W	8424W	8434W	Trimless 5/8" Drywall [‡]				-	-			10-1/8"	[10-11/16"]
	8415	8425	8435	Flat Trim	18"	18"	10"			19"	19"	9-7/8"	[10-15/16"]
	8416	8426	8436	1-¼" Square				21-3/8"	21-3/8"	[20-5/16"]	[20-5/16"]	8-7/8"	[9-15/16"]
	8417	8427	8437	2-½" Rolled								7-5/8"	[8-11/16"] [‡]
	8413	8423	8439**	Surface Mount	21-3/16"	21-3/16"	10-½"					-	-
2 FIRE DEPARTMENT VALVES: 1-½" or 2-½" Fire Department Valve with Cap and Chain Plus OR 1 FIRE DEPARTMENT VALVE & EXTINGUISHER: Cosmic 2-½ - 10 Galaxy 2-½ - 10 Mercury 2-½ - 11 Grenadier Saturn 15-25 Sentinel 5	8714W	8724W	8734W	Trimless 5/8" Drywall [‡]				-	-			8-½"	[8-½"]
	8715	8725	8735	Flat Trim	26"	26"	8"			27"	27"	7-7/8"	[8-15/16"]
	8716	8726	8736	1-¼" Square				29-3/8"	29-3/8"	[28-5/16"]	[28-5/16"]	6-7/8"	[7-15/16"]
	8717	8727	8737	2-½" Rolled								5-5/8"	[6-11/16"] [‡]
	8713	8723	8739**	Surface Mount	29-3/16"	29-3/16"	8-½"					-	-
	8614W	8624W	8634W	Trimless 5/8" Drywall [‡]				-	-			10-1/8"	[10-11/16"]
	8615	8625	8635	Flat Trim	26"	26"	10"			27"	27"	9-7/8"	[10-15/16"]
	8616	8626	8636	1-¼" Square				29-3/8"	29-3/8"	[28-5/16"]	[28-5/16"]	8-7/8"	[9-15/16"]
	8617	8627	8637	2-½" Rolled								7-5/8"	[8-11/16"] [‡]
	8613	8623	8639**	Surface Mount	29-3/16"	29-3/16"	10-½"					-	-
DUAL CABINET: FD VALVE PLUS EXTINGUISHER : Any Extinguisher (Except Sentinel 15-20, Nebula 250)	8014W	8024W	8034W	Trimless 5/8" Drywall [‡]				-	-			9-1/8"	[9-11/16"]
	8015	8025	8035	Flat Trim	16"	40"	9"			17"	41"	8-7/8"	[9-15/16"]
	8016	8026	8036	1-¼" Square				19-3/8"	43-3/8"	[18-5/16"]	[42-5/16"]	7-7/8"	[8-15/16"]
	8017	8027	8037	2-½" Rolled								6-5/8"	[7-11/16"] [‡]
	8013	8023	8039**	Surface Mount	19-3/16"	43-3/16"	9-½"					-	-

*Add 5/8" wall depth for cabinets with aluminum frames. ‡ Trimless models may be installed before drywall. ** Rolled edge
See submittal and installation instructions for more information and knockout locations.



6415F10
with Optional Fire Hose



6335G17
with Etched Frosted Glass



6535V10

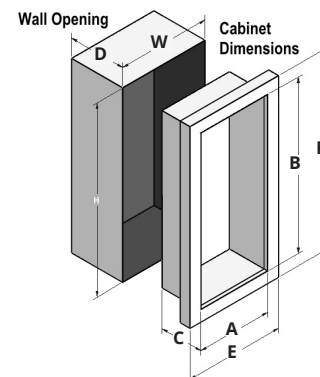



ARCHITECTURAL SERIES DOOR STYLES

	Solid	Full Glass	Vertical Duo	Horizontal Duo	Centered Horizontal Duo	Small Window	Textured Panorama	Clear Panorama
Standard Pull	S21 	F 	V 	D 	Option Not Available		P 	C70
Standard Pull & Saf-T-Lok	L22 	G 	W 	E 	A* 	B 	Q 	C71
Recessed Pull	S21A 	F_A 	V_A 	D_A 	Option Not Available		P_A 	
Recessed Pull & Saf-T-Lok	L22A 	G_A 	W_A 	E_A 	A_A 	B_A 	Q_A 	



Glazing	10 Clear Acrylic	13WS WireShield	15 Bronze Acrylic	16 Gray Acrylic	17 Clear Tempered	18 Laminated Safety

ClearVu Glazing	25 Clear Acrylic	26 Red Acrylic	27 Bronze Acrylic	Panorama P&Q Glazing	40-43 Vertical Lettering	45-48 Horizontal Lettering	50-53 Ascending Lettering

* Crownline Option

See pages 28-31 for Handles, Locks, Lettering, Signage & Alarms

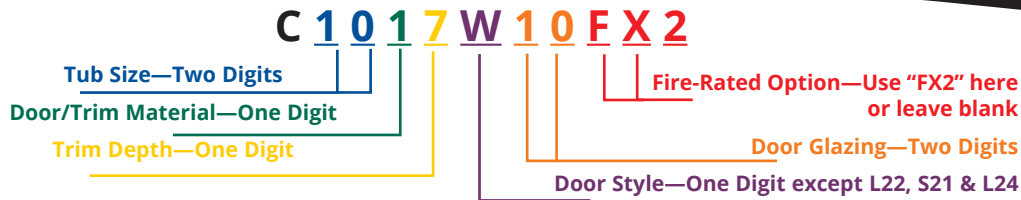

TUB SIZE—TWO DIGITS							
Ambassador, Academy, Cosmopolitan, Cavalier, Panorama		Embassy		Crownline		AED CABINETS	
81	9" x 18" x 5-1/2"	56	10-1/2" x 24" x 5-3/4"	60	24" x 30" x 6"	14	14" x 14" x 6-3/4"
17	10-1/2" x 24" x 5"	57	16" x 32" x 7-3/4"	61	24" x 30" x 8"	19	18" x 18" x 8"
18	10-1/2" x 24" x 5-1/2"	59	16" x 40" x 8-3/4"	62	24" x 34-3/4" x 6"	79	14" x 37" x 7"
10	10-1/2" x 24" x 6"	55	18" x 18" x 7-3/4"	64	24" x 34-3/4" x 8"	Royal 3600 Series	
20	12" x 27" x 7-3/4"	58*	32" x 32" x 7-3/4"	66	24" x 38-3/4" x 8"		
30*	16" x 32" x 7-3/4"	Orbit		63	30" x 30" x 8"	36	12" x 36" x 8"
40*	20" x 27" x 7-3/4"			65	32-3/4" x 34-3/4" x 8"	72	32-3/4" x 38-3/4" x 8"
Clear Vu		21	12" x 27" x 3-1/4"	85	18" x 18" x 8"		
		84	18" x 18" x 10"	87	26" x 26" x 8"		
15	10-1/2" x 24" x 4"			86	26" x 26" x 10"		
25	14" x 30" x 4"			80	16" x 40" x 9"		
45*	28" x 30" x 4"						

Note: For surface mount cabinets, add 3 3/16" to width and height measurements. See product page for wall opening dimensions.

DOOR/TRIM MATERIAL—ONE DIGIT		TRIM DEPTH - ONE DIGIT			
1	Cold Rolled Steel, White powdercoat finish	2	Semi-Recessed 4"	Rolled edge	With Flush Pull
2	Aluminum, #180 clear satin anodized finish	3	Surface Mount	Square edge	
3	Stainless Steel, #4 satin finish	4	Trimless recessed flange		For 5/8" Drywall or 3/4" Plaster
4	Bronze, US10 satin clear coated finish	5	Full recessed 3/8"	Square edge	
5	Brass, US3 polished coated finish	6	Semi-recessed 1-1/4" or 1-1/2"	Square edge	
7	Brass, US4 Satin	7	Semi-recessed 2-1/2" or 3"	Rolled edge	
8	Bronze, US10B Oil-rubbed	8	Semi-recessed 4-1/2"	Rolled edge	
9	Aluminum, Dark Brown Anodized	9	Surface mount	Rolled edge	

*Note: Bronze and brass are not available in 30, 40, 45, or 58 tub sizes.

Note: Bronze and brass are not available in #8, 9 or 2 trim depths.

DOOR STYLES - ONE DIGIT EXCEPT L22, S21 & L24			
STANDARD DOORS		PANORAMA DOORS	
F	Full glazing, pull handle	G	Full glazing, pull handle, Saf-T-Lok™
V	Vertical Duo, pull handle†	W	Vertical Duo, pull handle†, Saf-T-Lok™
D	Horizontal Duo panel, pull handle	E	Horizontal Duo panel, pull handle, Saf-T-Lok™
S21	Solid (no glazing), pull handle†	L22	Solid (no glazing), pull handle, Saf-T-Lok™
L24	Solid (no glazing), Saf-T-Lok™, no handle	B10	Small Acrylic, pull handle, Saf-T-Lok™
		A	Centered Duo panel, pull handle, Saf-T-Lok™
		P	Colored acrylic, pull handle
		Q	Colored acrylic, pull handle, Saf-T-Lok™
		C70	Framless 3/16" clear polycarbonate, with pull handle
		C71	Framless 3/16" clear polycarbonate, with pull handle & Saf-T-Lok™

DOOR GLAZING							
FOR STANDARD DOORS		FOR PANORAMA DOOR STYLE P&Q 3/16" ACRYLIC		FOR PANORAMA DOOR STYLE C		FOR CLEAR VU	
10	0.090" Clear acrylic	40	Black acrylic with white vertical letters	70	Clear polycarbonate	25	Clear Bubble
13WS	1/4" Clear wire w/safety film	41	Red acrylic with white vertical letters	71	3/16" Clear polycarbonate with Saf-T-Lok™	26	Red Bubble
15	1/8" Bronze acrylic	42	White acrylic with black vertical letters			27	Bronze Bubble
16	1/8" Gray acrylic	43	White acrylic with red vertical letters				
17	1/8" Clear tempered glass	45	Black acrylic with white horizontal letters				
18	1/4" Clear safety glass	46	Red acrylic with white horizontal letters				
		47	White acrylic with black horizontal letters				
		48	White acrylic with red horizontal letters				
		50	Black acrylic with white ascending letters				
		51	Red acrylic with white ascending letters				
		52	White acrylic with black ascending letters				
		53	White acrylic with red ascending letters				



9263Z30



916AZ30

CLASSIC SERIES: ECONOMY GALVANNEAL OR ALUMINUM

Our Classic Series provides a durable cabinet for use in exterior or damp conditions. Select from either a surface mount or recessed version.

PRODUCT DETAILS:

Tub and Door Frame: White powder coated cabinet of rust-resistant galvanized steel, or aluminum

Door: .060" acrylic front for protection from the elements. Breaker bar and lock standard.

Trim: Surface mount or semi-recessed versions with a 2-3/4" or 4-1/2" trim flange

Fire-Rated Option: No

Options at Additional Cost: Optional colors



5019G20



521AN20

DECORLINE SERIES: ECONOMY STEEL OR ALUMINUM

The Decorline Series offers an economical solution for interior or exterior applications. Select from a wide range of sizes that will fit most 2-1/2-10 lb extinguishers. Choose from 2-1/2", 3" or 4-5/8" trim or a surface mount design.

PRODUCT DETAILS:

Construction: Cold rolled steel tub (interior) or aluminum (exterior) with white or gray hammertone powder coat finish

Trim: Models with trim feature 2" wide trim in either 2.5" or 4.25" depth, depending on model

Door: Models with "AN" designation have slide in acrylic front secured by clips and tab for lock at top. All other models have door with continuous hinges and either solid door or door with acrylic window top and breaker bar with chain.

Fire-rated Option: No

Options at Additional Cost: Brass or Abus padlock for "AN" models. Optional colors.



5017G20



502AN20

ECONOMYLINE SERIES: ECONOMY SURFACE-MOUNTED

A cost effective selection in either an aluminum or steel cabinet that can be locked with a padlock for tamper-resistance.

PRODUCT DETAILS:

Construction: Gray Hammertone powder coated cabinet cold rolled steel tub or rust-resistant aluminum

Door: Sliding .060 clear acrylic front with retainer clip. Breaker bar with chain, pre-drilled holes on top lip for padlock.

Fire-Rated Option: No

Options at Additional Cost: Other colors, brass padlock, Abus padlock. See Page 23.



5113N20



CLASSIC

COMPATIBLE EXTINGUISHERS	GALVANEAL STEEL	ALUMINUM	PREVIOUS MODEL	STYLE	TUB I.D.			WALL OPENING			CABINETS PER CARTON
					W	H	D	W	H	D	
Cosmic 2-½ - 6 Galaxy 2-½ - 6 Mercury 2-½ - 5 Sentinel 5	916AZ30	912AZ30	99GT	2-¾" Trim Flange	8-½"	19-13/16"	6-¼"	9"	20-15/16"	3-¾"	2
	916Z30	912Z30	99G	Surface Mount				-	-	-	2
Cosmic 2-½ - 10 Galaxy 2-½ - 10 Mercury 2-½ - 5 Sentinel 5	926AZ30	922AZ30	999GT	2-¾" Trim Flange	9-½"	25-¾"	6-¼"	10"	26-¼"	3-¾"	2
	926Z30	922Z30	999G	Surface Mount				-	-	-	2
Any Cosmic, Any Galaxy, Any Mercury, Any Saturn Grenadier P Sentinel 5	936AZ30	932AZ30	104GT	4-½" Trim Flange	10-½"	29-¾"	8-¼"	11"	30-¼"	4"	1
	936Z30	932Z30	104G	Surface Mount				-	-	-	1

DECORLINE

COMPATIBLE EXTINGUISHERS	STEEL	ALUMINUM	PREVIOUS MODEL	STYLE	TUB I.D.			FRAME O.D.		WALL OPENING			CABINETS PER CARTON
					W	H	D	W	H	W	H	D	
SLIDE-IN ACRYLIC FRONT - NO TUB													
Cosmic 2-½ - 5-½ Galaxy 2-½ - 5-½ Mercury 2-½ - 5	631AN20 (no tub)	-	928X	4-¾" Trim	9-⅞"	28"	4-½"	12-½"	31"	9-¼"	28-¼"	-	2
SLIDE-IN ACRYLIC FRONT - SEMI RECESSED WITH BREAKER BAR													
Cosmic 2-½ - 6 Galaxy 2-½ - 6 Mercury 2-½ - 5	501AN20	502AN20	818T	2-½" Trim	8-⅞"	18"	5-½"	11-¼"	21-¼"	9"	19"	4"	2
Cosmic 2-½ - 10 Galaxy 2-½ - 10 Mercury 2-½ - 5 Sentinel 5	511AN20	512AN20	924T	2-½" Trim	9-⅞"	24"	5-½"	12-½"	27"	10"	25"	4"	2
Any Cosmic, Galaxy Mercury, Saturn Grenadier P Sentinel 5	521AN20	522AN20	1028T	2-½" Trim	10-⅞"	28"	8-¼"	13-⅞"	31"	11"	29"	6"	2
	5218N20	5228N20	1028T4	4-⅝" Trim								4"	2
DOOR WITH CONTINUOUS HINGE - SOLID DOOR (S21) ACRYLIC DOOR & HANDLE(F20)ACRYLIC DOOR, HANDLE & LOCK (G20)													
Cosmic 2-½ - 6 Galaxy 2-½ - 6 Mercury 2-½ - 5	5017	5027	818TDH/818TDL 818TDHS	3" Trim	8-⅞"	18"	5-½"	11-¼"	21-¼"	9"	19"	3-¼"	2
	5019	5029	818DH/818DL 818DHS	Surface Mount				8-⅞"	18"	-	2		
Cosmic 2-½ - 10 Galaxy 2-½ - 10 Mercury 2-½ - 5 Sentinel 5	5117	5127	924TDH/924TDL 924TDHS	3" Trim	9"	23-7/8"	5-5/8"	12-¼"	27-¼"	10"	25"	3-¼"	2
	5119	5129	924DH/924DL 924DHS	Surface Mount				9-⅞"	24"	-	2		

ECONOMYLINE

COMPATIBLE EXTINGUISHERS	STEEL	ALUMINUM	PREVIOUS MODEL	STYLE	TUB I.D.			CABINETS PER CARTON
					W	H	D	
Cosmic 2.5-6 Galaxy 2.5-6 Mercury 2.5-5	5013N20	5023N20	818	Surface Mount	8-⅞"	18"	5-½"	2
Cosmic & Galaxy 2.5-10 Mercury 2.5-5 Sentinel 5	5113N20	5123N20	924	Surface Mount	9-⅞"	24"	5-½"	2
Any Cosmic, Galaxy, Mercury, Saturn Sentinel 5 Grenadier P	5213N20	5223N20	1028	Surface Mount	10-⅞"	28"	8-¼"	2



SMB SERIES: SURFACE-MOUNTED ACRYLIC BUBBLE AND STEEL CABINET

An economical surface mount bubble cabinet that accomodates up to a 5 lb Cosmic, Galaxy or Mercury extinguisher.

PRODUCT DETAILS:

Door and Trim: Cold rolled steel with six standard powder coated colors to choose from - black, white, red, bronze, brass, silver or gray hammertone. Flush cabinet doors with a- $\frac{5}{8}$ " door stop are attached by a continuous hinge and equipped with zinc plated handle and roller catch.

Bubble: Acrylic bubble allows 180° extinguisher visibility. 2- $\frac{1}{2}$ " projection.

Trim Style & Depth: This surface mount cabinet has a 3" rolled edge that forms a tub. 1- $\frac{3}{4}$ " face trim on frame and 1- $\frac{1}{4}$ " trim on door.

Extinguisher: Extinguisher must be mounted to back of tub using bracket

Fire-Rated Option: No



9123FJ30

SM SERIES: ECONOMICAL SURFACE-MOUNT ALUMINUM CABINET

An all-purpose aluminum economy cabinet with slide-in plexiglass door. Sizes to accomodate up to 20 lb extinguishers.

PRODUCT DETAILS:

Construction: All aluminum with white powder coat finish standard. Cabinet is hinged on top and plexiglass front slides in.

Door: Full Breakaway Plexiglass, with center pull handle and tamperproof security screws

Fire-Rated Option: No

Options at Additional Cost: Full TSHS Spanner Tool Head Screwdriver



1363D12

FB SERIES: FIBERGLASS FIRE EXTINGUISHER CABINET

The FB Series is a durable, surface mount fiberglass cabinet that is resistant to salt air, chemicals, moisture, dust, insects and temperature extremes. Fits up to 20 lb fire extinguishers.

PRODUCT DETAILS:

Construction: Door and tub are UV-resistant fiberglass with high-visibility red finish and 5" x 9" Fire Extinguisher Lettering

Door: Gasketed door with 6" x 9" gasketed view window and corrosion-resistant aluminum handle. All cabinets come standard with a full length stainless steel hinge attached by rivets. Door is tightly latched against the silicone gasket by two stainless steel snap latches.

Fire-Rated Option: No



SMB

COMPATIBLE EXTINGUISHERS	WHITE	HAMMERTONE	BRASS	BRONZE	SILVER	RED	BLACK	TRIM STYLE	TUB I.D.			FRAME O.D.		
	SMB-W	SMB-GH	SMB-BA	SMB-BR	SMB-SI	SMB-R	SMB-B		W	H	D	W	H	D
Cosmic 2.5-10 Galaxy 2.5-10 Mercury 2.5-5								Surface Mount 3" Rolled Edge	13- ³ / ₁₆ "	27- ⁵ / ₁₆ "	3"	13- ¹⁵ / ₁₆ "	27- ⁷ / ₁₆ "	5- ¹ / ₂ "

SM

COMPATIBLE EXTINGUISHERS	MODEL	PREVIOUS MODEL	TRIM STYLE	TUB I.D.			FRAME O.D.		
				W	H	D	W	H	PROJECTION
Cosmic 2.5-5.5 Galaxy 2.5-5.5 Mercury 2.5-5	9123FJ30	6473/SM-5	Surface Mount	8- ⁷ / ₁₆ "	19- ³ / ₄ "	6"	8- ¹ / ₂ "	20"	6- ¹ / ₄ "
	9123FG30		Surface Mount						
Cosmic 2.5-10 Galaxy 2.5-10 Mercury 2.5-5, Sentinel 5	9223FJ30	6573/SM-10	Surface Mount	9- ⁷ / ₁₆ "	25- ¹ / ₂ "	6"	9- ¹ / ₂ "	25- ³ / ₄ "	6- ¹ / ₄ "
	9223FG30		Surface Mount						
Any Cosmic, Galaxy, Mercury, Saturn Sentinel 5, Grenadier P	6773FJ30	SM-20	Surface Mount	10- ¹⁵ / ₁₆ "	27- ³ / ₄ "	8"	11"	28"	8- ³ / ₄ "

FJ30 Center Pull Handle w/ Tamperproof Screws & Clear Plexiglass
FG30 Center Pull Handle w/ Cylinder Lock & Clear Plexiglass

FB SERIES

COMPATIBLE EXTINGUISHERS	MODEL	STYLE	TUB I.D.			FRAME O.D.		
			W	H	D	W	H	D
Cosmic 2.5-10 & 20E (FE20C) Galaxy 2.5-10 Any Mercury Saturn 15	1353D12	Surface Mount Radius Corners	10- ¹ / ₄ "	23- ¹ / ₄ "	8- ¹ / ₂ "	13- ¹ / ₄ "	26- ¹ / ₈ "	9- ³ / ₄ "
Any Cosmic, Any Galaxy, Any Mercury Saturn 15, Sentinel 5-10, Grenadier P	1363D12	Surface Mount Radius Corners	12- ¹ / ₂ "	24- ¹ / ₈ "	9"	15- ³ / ₄ "	27- ¹ / ₈ "	10- ¹ / ₄ "
Any Cosmic, Any Galaxy, Any Mercury, Any Saturn Any Sentinel, Grenadier P	1373D12	Surface Mount Curved Top	16"	33"	12- ³ / ₄ "	19- ⁵ / ₈ "	36- ¹ / ₈ "	14"

ABS cabinets have been discontinued and replaced with Cato plastic cabinets. See pages 20-22.



CATO CHIEF SERIES - ECONOMY



Chief (white) showing hammer break tool



Chief (red) showing optional break bar



Island Chief (red)



Island Chief (white)

CHIEF: SURFACE-MOUNT PLASTIC FIRE EXTINGUISHER CABINETS

Cato's affordable fire extinguisher series, manufactured in the U.S., provides a dent and rust proof alternative to metal. Cato's Chief series fire extinguisher cabinets feature a security hexagonal lock and key to open and remove the trim and acrylic panel, which features scored lines to easily break when struck with tool in case of fire.

Tub and Trim Material: Injection molded high impact polystyrene in .110 thickness with ultra-violet inhibitors for UV resistance

Tub and Trim Colors: Available in red or white

Cover Material: .080 Acrylic front panel, grid scored for improved emergency access with break tool

Acrylic Colors: Available in clear or red (for best outdoor UV resistance)

Break Tool: Polypropylene injection molded aluminum tipped hammer with ribbed grip handle and a clear nylon coated stainless steel cable that matches trim color

Break Tool Option: Stainless steel break bar

Decals: UV resistant "FIRE" and "Break Panel" decals included

Hardware: ABS hexagonal lock and key installed

Sizes: Refer to table, listing model sizes with their compatible extinguishers from 2.5 - 20 lbs

Additional Options: Fire extinguisher rust prevention tray

ISLAND CHIEF: SURFACE-MOUNT PLASTIC FIRE EXTINGUISHER CABINETS

Cato's Island Chief series fire extinguisher cabinets feature a security hexagonal lock and key to open and remove the trim and pull panel cover. The panel features a hand opening to easily pull panel out to gain access in case of fire.

Tub and Trim Material: Injection molded high impact polystyrene in .110 thickness with ultra-violet inhibitors for UV resistance

Tub and Trim Colors: Available in red or white

Cover Material: .030 PETG (polyethylene terephthalateglycol) panel with oval notch cut out to complete the pull panel design

Panel Colors: Available in clear only

Decals: UV resistant "FIRE" and "Tampering is a Felony" pull panel decals included

Hardware: ABS hexagonal lock and key installed

Sizes: Refer to table, listing model sizes with their compatible extinguishers from 2.5 - 11 lbs

Additional Options: Fire extinguisher rust prevention tray

CHIEF & ISLAND CHIEF

COMPATIBLE EXTINGUISHERS	PREVIOUS MODEL CHIEF	PREVIOUS MODEL ISLAND CHIEF	TUB I.D. W x H x D			TRIM O.D. W x H x D		
Cosmic 2.5-5.5 Galaxy 2.5-5.5	105-5	105-5 P	6"	16-3/4"	5-3/8"	8-1/4"	19-1/4"	6-3/4"
Cosmic 2.5-10 Galaxy 2.5-10 Mercury 2.5-11	105-10	105-10 P	6-3/4"	20-1/2"	6"	9-1/4"	23-1/4"	7-1/4"
Cosmic 2.5-20 Galaxy 2.5-20 Mercury 2.5-15.5 Sentinel 5, Saturn 15	105-20	Not available	9"	26"	8"	11-1/2"	28-1/2"	9-1/2"

See page 24 for current model number structure



Chief Pull to Open (red) also available in white



Chief Semi Recessed only available in white shown with included decal CL-412 "Fire Extinguisher"

CHIEF PULL TO OPEN: SURFACE-MOUNT PLASTIC FIRE EXTINGUISHER CABINETS

Cato's Chief Pull to Open series fire extinguisher cabinets feature a unique hinged acrylic door style with pull handle to allow quick access in case of fire.

Tub and Trim Material: Injection molded high impact polystyrene in .110 thickness with ultra-violet inhibitors for UV resistance

Tub and Trim Colors: Available in red or white

Cover Material: .080 Acrylic front panel

Acrylic Colors: Available in clear only

Decals: UV resistant "FIRE" decals included

Hardware: Black ABS Handle 3.75" long with a 1.25" projection, two stainless steel hinges, a zinc plated roller catch with strike plate, and hexagonal lock with key installed to secure trim to tub

Sizes: Refer to table, listing model sizes with their compatible extinguishers from 2.5 - 11 lbs

Additional Options: Fire extinguisher rust prevention tray

CHIEF SEMI RECESSED: SEMI RECESSED PLASTIC FIRE EXTINGUISHER CABINETS

Cato's Chief Semi Recessed fire extinguisher design is built with a 2.875" trim projection and meets ADA cabinet projection requirements. The hinged door is designed with a viewable acrylic window and pull handle.

Tub and Trim Material: Injection molded polypropylene in .15 thickness

Trim Style: 2-7/8" rounded edge

Tub and Trim Colors: Available **white** only

Cover Material: .080 Acrylic front panel

Acrylic Colors: Available in clear only

Decals: Red vertical "FIRE EXTINGUISHER" decal included, mounts to door or panel

Hardware: Stainless steel hinge, glass clip, zinc plated handle and roller catch

Sizes: Refer to table, listing model sizes with their compatible extinguishers from 2.5 - 10 lbs

Additional Options: Fire extinguisher rust prevention tray, cylinder lock with flexible cam

CHIEF PULL TO OPEN

COMPATIBLE EXTINGUISHERS	PREVIOUS MODEL	TUB I.D. W x H x D	TRIM O.D. W x H x D				
Cosmic 2.5-5.5 Galaxy 2.5-5.5	105-5 Z	8" 19-3/4" 6-3/8"	8-1/4"	19-1/4"	6-3/4"		
Cosmic 2.5-10 Galaxy 2.5-10 Mercury 2.5-11 Sentinel 5	105-10 Z	9-1/4" 23" 7"	9-1/4"	23-1/4"	7-1/4"		

CHIEF SEMI RECESSED

COMPATIBLE EXTINGUISHERS	PREVIOUS MODEL	* TUB I.D. W x H x D			TRIM O.D. W x H x D		
Cosmic 2.5-10 Galaxy 2.5-10 Mercury 2.5-5 Sentinel 5	405-10	8-1/2"	23-1/4"	5-5/8"	13-3/8"	27-5/8"	2-7/8"

* For wall opening W x H x D: 10-1/2" x 25" x 4"



10006R Hex Key

Included on Pull to Open, Chief, and Island Chief.
Also available in white. Key color matches trim color.

See page 24 for current model number structure



Warrior (red) also available in white

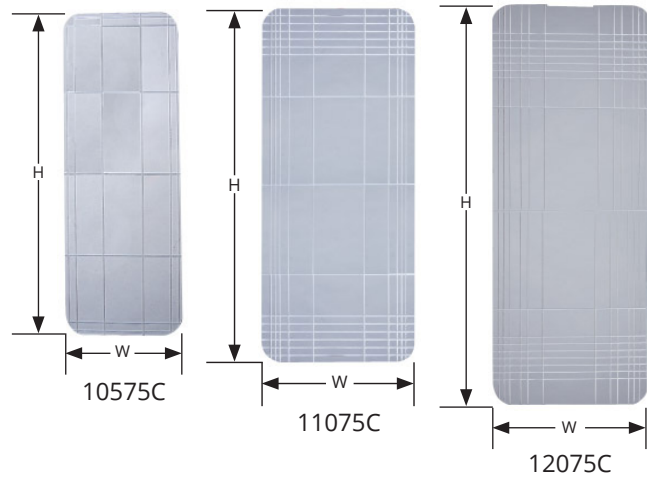

WARRIOR: SURFACE-MOUNT PLASTIC FIRE EXTINGUISHER CABINETS

Cato's Warrior series fire extinguisher cabinet is a two-piece construction with a locking seal. No additional padlock is required. Simply pull up to break the seal and remove the cover to access extinguisher inside.

Tube Material: Injection molded high-impact polystyrene in .110 thickness with UV inhibitors for UV resistance

Tube Colors: Available in red or white

Cover Material: .100 crystal polystyrene with pull handle located at the bottom and etched "PULL" lettering

Cover Colors: Available in clear or red (for best outdoor UV resistance)

Decals: UV resistant "FIRE" and "Crime Warning" decals included

Hardware: Plastic locking seal included, white only

Sizes: Refer to table, listing model sizes with their compatible extinguishers from 2.5 - 11 lbs

CUSTOMIZER PANEL: FIRE EXTINGUISHER CABINETS

Cato's patented UV resistant acrylic contains grid lines for trimming to size on-site. It fits most Economy line cabinets for 5, 10 and 20lb extinguishers.

Material: .080 Clear acrylic, UV resistant with scored grid lines

Additional info: Three sizes available to fit up to most Economy line 5, 10, and 20 lb fire extinguisher cabinets

Sizes: Refer to table

WARRIOR

COMPATIBLE EXTINGUISHERS	PREVIOUS MODEL	TUB I.D. W x H x D			TRIM O.D. W x H x D		
Cosmic 2.5-5 Galaxy 2.5-5 Mercury 2.5	95-5	8"	19"	6-3/8"	8-1/4"	19-1/4"	6-3/4"
Cosmic 2.5-10 Galaxy 2.5-10 Mercury 2.5-11 Sentinel 5	95-10	9"	23"	7"	9-1/4"	23-1/4"	7-1/4"

See page 24 for current model number structure

CUSTOMIZER PANEL		
MODEL	DIMENSIONS W x H	FITS CHIEF PREVIOUS MODEL
10575C	7-5/8" x 18-3/4"	105-5
11075C	8-5/8" x 22-5/8"	105-10
12075C	10-5/8" x 27-3/4"	105-20



95505
Locking Seal
Included with Warrior



CATO ACCESSORIES:

ACCESSORIES	
ITEM	DESCRIPTION
10300	Fire Extinguisher Rust Prevention Tray (not available for on previous model 105-20)



10300

Fire Extinguisher Rust Prevention Tray Accessory
(not available on cabinets for a 20 lb extinguisher; previous model 105-20)

DECALS	
ITEM	DESCRIPTION W x H
CL-401R	Fire Extinguisher "Fire" with red background 3" x 9"
CL-401W	Fire Extinguisher "Fire" with white background 3" x 9"
CL-403	"Fire Extinguisher" Arrow 4" x 18"
CL-412	"Fire Extinguisher" 1" x 15"
CL-413	"Fire Extinguisher" Arrow 4" x 12"
CL-415	"Break Panel" 2" x 3-1/2"
CL-416	"Felony Warning" Red 3" x 5"
CL-416A	Pull Panel "Felony Warning" 2-1/4" x 4"
CL-417	"In Case of Fire Pull Handle Firmly" 1" x 4"
CL-422	"Extinguisher Missing" 1-1/2" x 8-1/2"
CL-423	"Kitchen Suppression" 4-3/4" x 3"
CL-95	Pull Up Cover "Crime Warning" 6 x 5"



CL-401R or CL-401W
FIRE decal available with red or white background (matches tub color).
Included on all models except Chief Semi Recessed

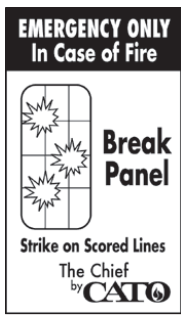

CL-415 Decal
Included with Chief



CL-416 Decal



CL-416A Decal
Included with Island Chief



CL-403
CL-413



CL-412
Included with Chief Semi Recessed



CL-417
Included with Chief Pull to Open



CL-422



CL-423



CL-95
Included with Warrior

Replacement parts and more information available. Please refer to submittals.



CATO CABINET PART NUMBER GUIDE & ACCESSORIES



PRODUCT SERIES - TUB SIZE								
Chief Island Chief Chief Pull to Open			Chief Semi Recessed			Warrior		
Tub Size	Previous Model	Fits Fire Extinguisher	Tub Size	Previous Model	Fits Fire Extinguisher	Tub Size	Previous Model	Fits Fire Extinguisher
105	105-5	5 lb	405	405-10	10 lb	950 (white)	95-5	5 lb
110	105-10	10 lb				955 (red)	95-5	5 lb
120	105-20	20 lb*				951 (white or red)	95-10	10 lb

* Not available on Island Chief and Chief Pull to Open

TUB / TRIM / ACRYLIC COVER COLOR					
All Chief Models Tub / Trim / Acrylic Cover Color		Warrior for 5 lb Cover Color		Warrior for 10 lb Tub / Cover Color	
01	WWC - White, White, Clear		(not available)	01	WC - White, Clear
02	WWR - White, White, Red		(not available)	02	WR - White, Red
13	WRC - White, Red, Clear	51	Clear Cover	51	RC - Red, Clear
51	RRC - Red, Red, Clear	52	Red Cover	52	RR - Red, Red
52	RRR - Red, Red, Red	(Warrior combinations shown below)			
63	RWC - Red, White, Clear				

OPENING METHOD							
Chief		Island Chief		Chief Pull to Open		Chief Semi Recessed	
H	Hammer*	P	Pull Panel	Z	Pull Handle	(none)	Pull Handle, non locking
B	Break Bar	Note - Opening method not needed in Warrior series				L	Cylinder Lock (optional)

*Hammer color matches trim color

PACKAGING			
Unassembled		Individually Packed	
(none)	Bulk packed based on qty Max per box packaging standards	I	Cabinets are individually assembled and packaged

*Cabinets come unassembled and bulk packed as standard option

BREAK TOOL - CHIEF ONLY
 (Hammer color matches trim color)

H Red Hammer Assembly	
H White Hammer Assembly	
B Stainless Steel Break Bar	

WARRIOR SERIES
 Tub/Cover Color Combinations

Warrior WC White body Clear cover	Warrior WR White body Red cover	Warrior RC Red body Clear cover	Warrior RR Red body Red cover

For more detailed information please refer to submittals.



SECURED FIRE ALARM COVER: PLASTIC FIRE ALARM COVER

Cato's Protective Alarm Cover with Security Cover is vandal resistant and contains a side slot to hold the break bar in place when not in use. It arrives fully assembled and is quick to install.

Body and Cover Material: Injection molded of high-density polypropylene, available in red only. Pull handle at the top is designed to ADA specifications.

Acrylic Material: .080 Acrylic front panel, grid scored for improved emergency access with break tool. Available in clear only.

Break Tool: Galvanized steel break bar and clear nylon coated stainless steel cable

Decals: UV resistant "BREAK PANEL" and "FIRE" decals included

Hardware: Mounting hardware and anchors are included

Sizes: Refer to table, listing models and dimensions. Available for recessed or surface mounted alarms.

Options: Gasket

PULL TO OPEN FIRE ALARM COVER: PLASTIC FIRE ALARM COVER

Cato's Pull to Open Fire Alarm Cover arrives fully assembled, is quick to install, and the cover can be opened quickly in case of emergency and remains open during inspection and maintenance.

Body Material: Injection molded of high-density polypropylene, available in red only

Cover Material: Injection molded copolymer polypropylene, available in clear only. Pull handle at the top is designed to ADA specifications.

Decals: UV resistant "PULL TO OPEN" and "FIRE" decals included

Hardware: Mounting hardware and anchors are included

Sizes: Refer to table, listing models and dimensions. Available for recessed or surface mounted alarms.

Options: Gasket

SIZES AND MOUNTING OPTIONS FOR SECURED FIRE ALARM COVER AND PULL TO OPEN FIRE ALARM COVER

PREVIOUS MODEL	ALARM MOUNTING	COVER I. D. W x H x D	COVER O. D. W x H x D	VIEWABLE WINDOW	WEIGHT
220R	Recessed Mounted Alarm	6-1/4" x 7-1/4" x 1-3/4"	7-1/2" x 8-1/4" x 2-1/4"	5" Square	1.5 lbs
220S	Surface Mounted Alarm	6-1/2" x 7-1/2" x 3-1/4"	7-1/2" x 8-1/4" x 3-3/4"	5" Square	1.7 lbs

Please see submittal for more detailed information



CL-419 Decal
Included with Secured Fire Alarm Cover Only
1-3/4" x 1-3/4"

Hardware
Included with both models



CL-420 Decal
Included with both models
1/2" x 1-1/2"

PULL TO OPEN

CL-418 Decal
Included with Pull to Open Fire Alarm Cover Only
1/2" x 4-1/2"



SECURITY AND DETENTION CABINETS

 FIRE-FX® UP TO 2 HOURS

JL Security and Detention Cabinets for fire extinguishers, fire hoses or fire department valves are constructed to meet maximum security requirements in areas where fire protection is required.



SVC-13 with Optional Detention Deadbolt & Color



SSFC-37 with Detention Deadbolt

PRODUCT DETAILS:

Cabinet Material & Finish: 12 gauge cold rolled steel with white powder coat, 14 gauge 304 stainless steel with #4 finish.

Construction: Cabinet is fully welded with with 1" wide trim on frame. Flush cabinet doors are mounted in a 5/8" door stop and attached by a heavy duty continuous hinge. Knockouts provided on non fire-rated valve and hose cabinets.

Trim Style & Depth: Fully Recessed with flat trim, Semi-recessed with 2-1/2" profile square trim or Surface mount model with square edge. Heavy duty masonry anchors are welded to frame on all recessed cabinets.

Locks: Mortise cylinder or deadbolt, detention deadlock or slam lock

Options at an Additional Cost: Paint colors, custom lock preps



CS2015F17

SCHOOL CABINETS

 FIRE-FX® UP TO 2 HOURS

JL School Cabinets for fire extinguishers are constructed of heavy duty materials for rough duty applications, and offer a range of durable options.

PRODUCT DETAILS:

Cabinet Material: 12 gauge cold rolled steel or 14 gauge 304 stainless steel. Door is available in 8 styles with 4 glazing choices.

Trim Style: Recessed - flat trim. Surface mount and semi-recessed models have a square edge.

Door, Tub & Trim Finish: White powder coat paint, #4 stainless steel.



HECIRL



HECIR

FIRE HOSE EQUIPMENT CABINET

This durable storage cabinet has cold rolled steel or galvanized steel construction for interior or exterior use. The top is angled with a 3" overhang to shed water.

PRODUCT DETAILS:

Construction: 16 gauge galvanized or cold rolled steel construction. Both are finished with red powder coat paint and features shelf and louvers on both sides of cabinet for ventilation. Optional 12" legs.

Hardware: Hasp for a padlock (by others) standard

Size: 58" W x 42" H x 18-1/2" D

Models:

HECIG: Galvanized & HECIGL - Galvanized with Legs

HECIR: Steel & HECIRL - Steel with Legs

Options at an Additional Cost: DFFH or 1403 "Fire Hose" decal, Locking chrome handle with top & bottom latching (must be ordered with cabinet in order to install rod latching system)

HRA SERIES: FIRE HOSE PIN RACK ASSEMBLY

Pin rack assembly includes a single jacket 1-1/2" hose for one-person operation. This basic unit contains the entire assembly including nozzle and couplings.

PRODUCT DETAILS:

Operation: One-man operation for immediate means of fire control

Ratings: 100 GPM at 65 psi at the nozzle. Hose is FM-approved, industrial fog nozzle, angle valve and pin rack are UL-rated.





SECURITY SERIES

COMPATIBLE EXTINGUISHER, HOSE & RACK	STEEL	STAINLESS STEEL	TRIM STYLE	TUB I.D.			FRAME O.D.*		WALL OPENING: NON-RATED [FIRE-RATED]		
				W	H	D	W	H	W	H	D
SECURITY FIRE EXTINGUISHER CABINETS (SFC)											
Cosmic 2.5-10 Galaxy 2.5-10 Mercury 2.5-5	SFC-11	SSFC-31	Flat Trim	10-1/2"	24"	7"	12-1/2"	26"	11-1/2"	25"	7-1/2" [8"]
	SFC-12	SSFC-32	2-1/2" Sqr. Trim						[12-1/2"]	[26-1/2"]	5" [5-1/2"]
	SFC-13	SSFC-33	Surface Mt. Sq.	13"	26-1/2"	8"	13"	26-1/2"	-	-	-
Cosmic 2.5-20 Galaxy 2.5-20 Mercury 2.5-15 Saturn 15 Sentinel 5	SFC-15	SSFC-35	Flat Trim	12"	27"	8-1/2"	14"	29"	13"	28"	9" [9-1/2"]
	SFC-16	SSFC-36	2-1/2" Sqr. Trim						[14"]	[29-1/2"]	6-1/2" [7"]
	SFC-17	SSFC-37	Surface Mt. Sq.	14-1/2"	29-1/2"	10"	14-1/2"	29-1/2"	-	-	-
SECURITY VALVE CABINETS (SVC)											
1-1/2" Fire Department Valve 2-1/2" Fire Department Valve	SVC-11	SSVC-31	Flat Trim	18"	18"	8-1/2"	20"	20"	19"	19"	9" [9-1/2"]
	SVC-12	SSVC-32	2-1/2" Sqr Trim						[20"]	[20-1/2"]	6-1/2" [7"]
	SVC-13	SSVC-33	Surface Mt. Sq.	20-1/2"	20-1/2"	10"	20-1/2"	20-1/2"	-	-	-

Knockouts 11 & 31: 2 each side - 5" from top, bottom & back. 12 & 32: 2 each side - 4.5" from top, bottom and back †

SECURITY HOSE CABINETS (SHC)											
1-1/2" Hose Rack & Extinguisher 2-1/2" Hose Rack & Extinguisher 1-1/2" Fire Dept Valve & Extinguisher 2-1/2" Fire Dept Valve & Extinguisher	SHC-11	SSHHC-31	Flat Trim	32-3/4"	34-3/4"	8"	34-3/4"	36-3/4"	33-3/4"	35-3/4"	8-1/2" [9"]
	SHC-12	SSHHC-32	2-1/2" Sqr. Trim						[34-3/4"]	[36-3/4"]	6" [6-1/2"]
	SHC-13	SSHHC-33	Surface Mt. Sq.	36-3/4"	38-3/4"	8"	36-3/4"	38-3/4"	-	-	-

Knockouts: 2 each side - 4" from top bottom and back.

†Knockouts not available on Fire-Rated Cabinets *Fire rated cabinets Add 1" to frame OD.

SCHOOL SERIES

COMPATIBLE EXTINGUISHERS	STEEL	TRIM STYLE	TUB I.D.			FRAME O.D.*		WALL OPENING: NON-RATED [FIRE-RATED]		
			W	H	D	W	H	W	H	D
Any Cosmic Any Galaxy Any Mercury Any Saturn Grenadier P Sentinel 5-10	CS2015	Flat Trim	12	27"	7-3/4"	14"	29"	13"	28"	8" [8-3/4"]
	CS2017	2-1/2" Sqr. Trim						[14"]	[29"]	5-1/2" [6-1/2"]
	CS2013	Surface Mt. Sq.	14-1/2"	29-1/2"	8"	14-1/2"	29-1/2"	-	-	-

* Fire rated cabinets - Add 1" to frame OD

HRA SERIES

MODEL #	PREV. MODEL	HOSE LENGTH	HOSE DIA.	HOSE TYPE	VALVE SIZE	STORED HOSE HEIGHT	HOSE TOP TO VALVE CTR	RACK WIDTH	OVERALL WIDTH	RACK DEPTH	CLASS OF SERVICE
1-1/2" HOSE AND 1-1/2" VALVE BASIC UNIT											
HRA050B	3005	50'	1-1/2"	Poly Lined Hose	1-1/2"	23"	3-7/8"	17-7/8"	19-3/4"	4-1/8"	II
HRA075B	3007	75'				25"					
HRA100B	3010	100'				25"					
1-1/2" HOSE AND 1-1/2" VALVE WITH CHROME PLATED BRASS FITTINGS											
HRA050CH	3105	50'	1-1/2"	Poly Lined Hose	1-1/2"	23"	3-7/8"	17-7/8"	19-3/4"	4-1/8"	II
HRA075CH	3107	75'				25"					
HRA100CH	3110	100'				25"					
1-1/2" HOSE AND 2-1/2" VALVE BASIC UNIT											
HRA050B-2.5	3205	50'	1-1/2"	Poly Lined Hose	2-1/2"	23"	4-1/8"	17-7/8"	20-1/16"	4-1/8"	II and III
HRA075B-2.5	3207	75'				25"					
HRA100B-2.5	3210	100'				25"					
HRA125B-2.5	3212	125'				28"					

See Crownline Series for Cabinets to fit the HRA Series and other fire hose rack assemblies



DECALS & DIECUTS



Vertical Decal



Vertical Decal



Vertical Diecut



(2" Lettering)



Ascending Diecut



PHCD-RED



Horizontal Decal



Horizontal Diecut

MODEL	ORIENTATION	DECAL OR DIECUT	TITLE / DESCRIPTION	COLORS	SIZE
LDVRF	Vertical	Decal	FIRE EXTINGUISHER	Red & Clear	2" x 19"
LDVWF				White & Clear	
LDVBF				Black & Clear	
LDCVRF	Vertical	Diecut	FIRE EXTINGUISHER	Red	¾" x 18"
LDCVRF				Red (Reverse)	
LDCVWF				White	
LDCVWF				White (Reverse)	
LDCVBF				Black	
LDCVBF				Black (Reverse)	
LDCVRF-ESM-A				Vertical	
LDCVBF-ESM-A	Black				
LDCHRFE-2	Ascending	Diecut	FIRE EXTINGUISHER Fits architectural cabinets except for 8100 & Clear Vu (2" Lettering meets IBC)	Red	4-½" x 21"
LDCHWFE-2				White	
LDCHBFE-2				Black	
LDCARFE	Ascending	Diecut	FIRE EXTINGUISHER	Red	1-½" x 22"
LDCABFE				Black	¾" x 18"
PHCD-RED	Vertical	Decal	IN CASE OF FIRE PULL HANDLE	Red & White	1" x 4-¼"
LDHRFE	Horizontal	Decal	FIRE EXTINGUISHER	Red & White	7-½" x 2-¼"
LDHWFE				White	
LDHBFE				Black & White	
LDCHRFE	Horizontal Diecut	Diecut	FIRE EXTINGUISHER	Red	2-¼" x 7-¾"
LDCHWFE				White	
LDCHBFE				Black	



LD469Z82



DRFA



DRWF



S26



1403

FIRE HOSE VALVE

LDCHRFH



LDCHRFB



LDCHRFDV-R



FDVO

MODEL	SHAPE	TITLE / DESCRIPTION	COLORS	SIZE
LD469Z81	Graphic - Decal	FIRE EXTINGUISHER INSIDE	Red & White	5" x 7"
LD469Z82			Red & White	7" x 10"
DRFA	Vertical - Decal	FIRE EXTINGUISHER ARROW	Red & White	12" x 3-1/2"
DRWF	Square - Decal	WARNING (CA Penal Code)	Red & White	4" x 4"
S26	Horizontal - Graphic	FIRE EXTINGUISHER (CLASS K) English/Spanish	Red & White	11-7/8" x 7-3/4"
1403	Horizontal - Decal	FIRE HOSE (3" high lettering)	Black & Red	4" x 9"
LDCHRFH	Horizontal - Diecut	FIRE HOSE VALVE	Red	1" x 11-1/2"
LDCHRFB	Horizontal - Diecut	FIRE BLANKET	Red	7-7/8" x 1"
LDCHRFDV-R	Horizontal - Diecut	FIRE DEPT. VALVE - (2" Lettering for IBC)	Red	10-1/4" x 4-3/8"
FDVO	Octagonal - Decal	FIRE DEPARTMENT VALVE	Red, Black & White	6" x 6"
LDCVRFDV	Vertical - Diecut	FIRE DEPT VALVE	Red	3/4" x 21-1/2"
DCVRFDV-R			Red (Reverse)	3/4" x 21-1/2"
LDCHRFDV	Ascending - Diecut	FIRE DEPARTMENT VALVE	Red	1" x 17"
LDCVRFSCV-R	Vertical - Diecut	FIRE SPRINKLER CONTROL VALVE	Red	3/4" x 18"
DCVRFHV	Vertical - Diecut	FIRE HOSE VALVE	Red	3/4" x 17"



LDCVRFDV DCVRFDV-R

PLASTIC SIGNS

MODEL	DESCRIPTION	SHAPE	SIZE
22S	FIRE EXTINGUISHER	3D angle	4" x 12"
23S		3D tent	4" x 18"
24S		3D tent	5" x 6"
25S		Flush Vertical	4" x 12"
PWS-FE-GLOW		3D angle	18" X 1" X 4"
PWS-FE-GLOW-3W		3D tent	4" X 7-1/2" X 18"
SATURN SIGN	Class K Fire Extinguisher Sign, 3 languages	Graphic flush sign	10-7/8" X 6-15/16"
SATURN SIGN-RED	Class K Fire Extinguisher Sign, 2 languages	Graphic flush sign	11-7/8" X 7-6/8"

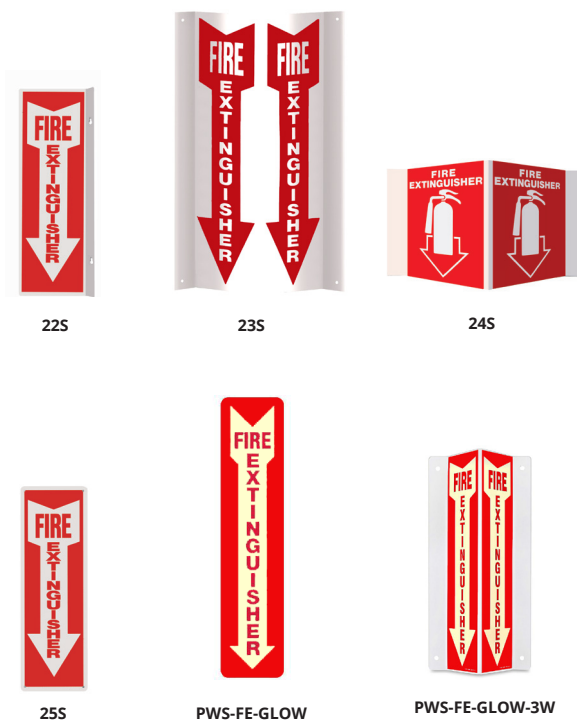

SATURN SIGN



SATURN SIGN-RED



ALARMS, LOCK BOXES, & BRACKETS

ALARMS & LOCK BOXES			
	MODEL	DESCRIPTION	SIZE
ALARM	CA	Commander alarm	
	BA	Brigadier alarm	
	SA	Strobe alarm (This alarm only operates when connected with the Commander Alarm)	
Lock Box	LB	Lock box (with padlock tab)	4" x 6" x 2-1/2"
	LBFD	Fire Department lock box (with padlock tab)	4" x 6" x 1-1/2"
	CKBRC	Security lock box recessed mount (shown with optional mortise lock)	5-1/4" x 5-1/4" x 2-1/2", 1-3/8" flange
	CKBSM	Security lock box surface mount (shown with optional mortise lock)	5" x 5" x 2-1/2"
	PL	Keyed-alike Abus padlock	
	PLB	Samson brass keyed-alike padlock	
	LL-24KIT	Break glass lock lever assembly (can only be ordered with cabinet or as a replacement)	
	HCM	Breaker bar with chain	

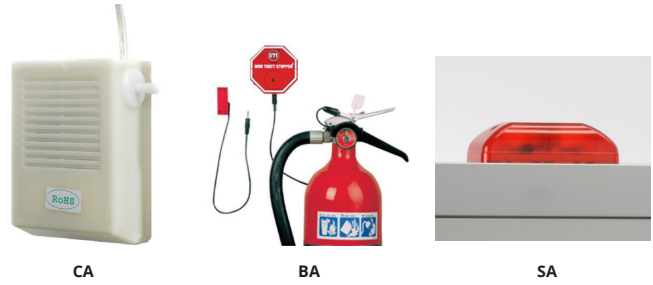

CA

BA

SA



LB

LBFD

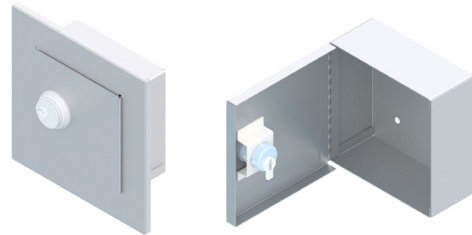

CKBRC

CKBSM



PL

PLB

LL-24KIT

HCM

FIRE EXTINGUISHER BRACKETS	
MODEL	OPTIONAL FOR FIRE EXTINGUISHER MODEL
MB809C	FS05C
MB810C	FM11C, FM15C, FK15C, FK25C, FS10C, FS15C, FP02C
MB811C	FE20C, FE30C, FS20C, FG20C, FPK20C
MB818C	FE05C, FG055C, FM05C, FPK05C, *FE05BC
MB846C	FE10C, FG10C, FPK10C
MB817C*	FE02C, FG02C, FM02C, FPK02C

*Standard for Extinguisher Model

FIRE EXTINGUISHER J-HOOKS	
MODEL	FITS THESE FIRE EXTINGUISHER MODELS
J-HOOK FE05C	FE02C, FE05C, FPK02C, FPK05C, FG02C, FG055C, FM02C, FM05C
J-HOOK FE10C	FE10C, FPK10C, FG10C, FS05C
J-HOOK FE20C	FE20C, FPK20C, FPK30CBV, FG20C, FS10C, FS15C, FM11C, FM15C

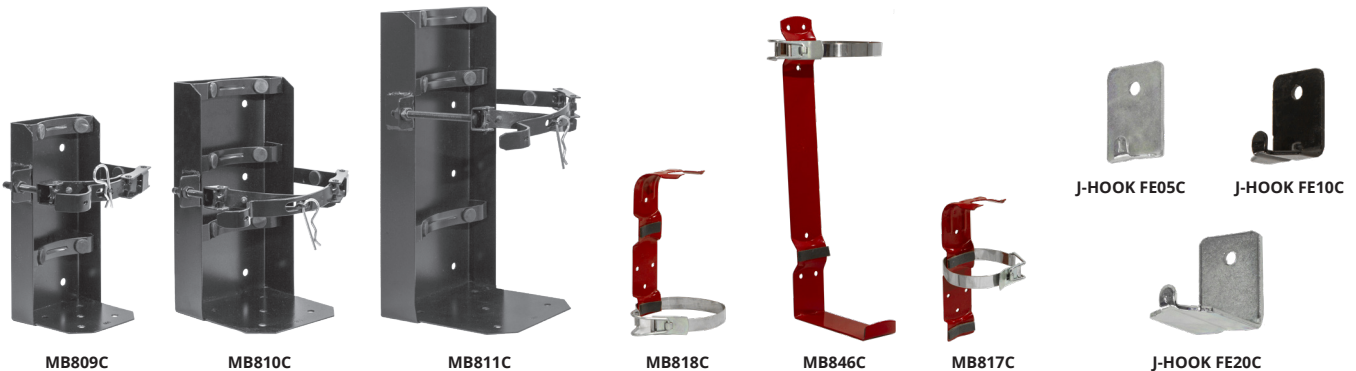

MB809C

MB810C

MB811C

MB818C

MB846C

MB817C

J-HOOK FE05C

J-HOOK FE10C

J-HOOK FE20C



ACCESSORIES: HANDLES			
	MODEL	DESCRIPTION	MATERIAL
HANDLES	PUF	Futura "FIRE" handle	Mill
	PUFW		White Paint
	PUFR		Red Paint
	PRH	Flush, plastic pull handle	Black
	PUS-US10B	Satin oil-rubbed bronze pull	US10B
	PUS-US10	Satin bronze pull	Bronze
	PUS-US3	Polished brass pull	Brass
	PUS-US32D	Stainless steel pull	Stainless
	PUCH	Zinc pull with chrome finish	Chrome
	PUS	Standard on most cabinets	Zinc
	LH	Lever handle (can only be ordered with cabinet or as a replacement)	Chrome



FIRE PROTECTION COLOR CHART

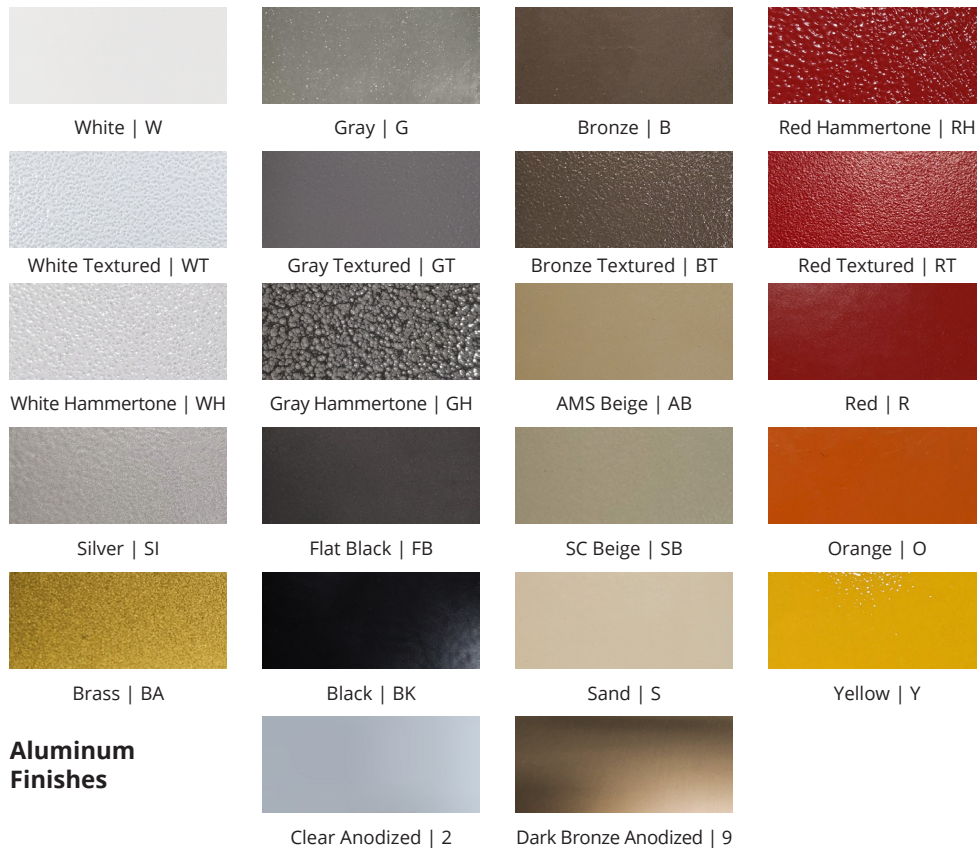

Colors shown in this catalog are approximate. Contact sales@activarcpg.com to request a sample.



CHECK OUT ALL OUR BRANDS WITH A VARIETY OF PRODUCTS!

Manufacturing locations: Bloomington, MN | Commerce, CA | Burnaby, BC, Canada

Warehouses: Dallas, TX | Chicago, IL | Seattle, WA | Atlanta, GA | Lancaster, PA | Fort Myers, FL | Salt Lake City, UT



ROOF ACCESSORIES



ACCESS PANELS

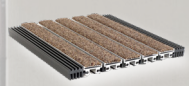

**ENTRANCE MATS,
GRATES, & GRILLES**



VISION LITES



DOOR LOUVERS



**SMOKE
VENTS**



ACTIVAR CONSTRUCTION PRODUCTS GROUP INC.

800-554-6077

sales@activarcpg.com

www.activarcpg.com