



THEMALBLOCK™ SERIES ENERGY-EFFICIENT ROOF HATCH

Thermally broken roof hatches provide a solution to reducing building energy costs with an R value of 20



ThermalBlock Series Roof Hatch Benefits:

- The durable construction and finish are designed to withstand heat, cold and UV exposure.
- 3" of polyisocyanurate insulation in both the curb and cover give the roof hatch a thermal resistance of R-20.
- A continuous seal around the cover maintains an air barrier between interior and exterior.
- Counterbalanced lid and easy-to-operate handle allow one-handed operation.



ACTIVAR CONSTRUCTION PRODUCTS GROUP INC.

1-800-554-6077 | SALES@ACTIVARCPG.COM
©2023 Activar Construction Products Group, Inc.

THEMALBLOCK™ SERIES ENERGY-EFFICIENT ROOF HATCH



How Does the ThermalBlock System Work?

Two continuous gaskets with low thermal conductivity create a thermal block between the outside and the inside.

When the weather outside is colder, this combination of insulation and gasketing moderates the temperature on the inside of the roof hatch reducing condensation and icing. The roof hatch can also reduce the amount of heat transferred from a warmer exterior, keeping air conditioning costs lower.

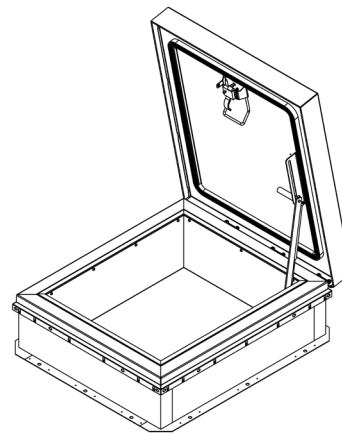
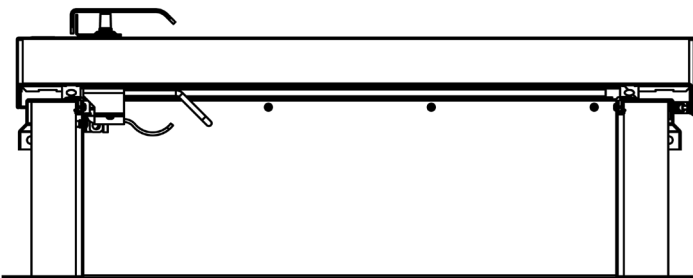

PRODUCT SPECIFICATIONS:

- **Material:** 11 gauge aluminum.
- **Standard Finish:** Mill.
- **Curb:** Thermally broken single wall curb and counterflashing with tabs.
- **Cover:** Stiffened to support a live load of 40psf.
- **Gasket:** Extruded EPDM adhesive backed acoustic gasket seal, continuous around curb and cover to assure a continuous seal.
- **Insulation:** 3" polyisocyanurate in curb and cover with thermal resistance R-20
- **Sizes:** Minimum 26" x 24", Maximum: 48" x 120"

MODEL	W X L	ACCESS	WEIGHT
RHTBA-1	36"x 30"	Ladder	107 lbs
RHTBA-2	30"x 54"	Stair	128 lbs
RHTBA-3	30"x 96"	Stair	172 lbs
RHTBA-4	36"x 36"	Ladder	145 lbs
RHTBA-5	48"x 48"	Ladder	235 lbs

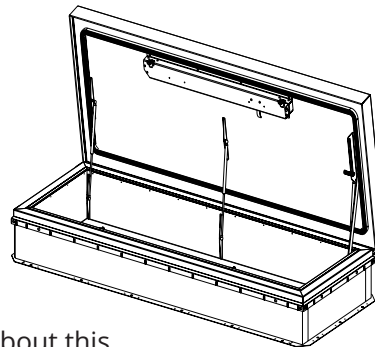

Visit our webpage for submittals and more information about this product: <http://www.activarcpg.com/>



ACTIVAR CONSTRUCTION PRODUCTS GROUP INC.

1-800-554-6077 | SALES@ACTIVARCPG.COM

©2023 Activar Construction Products Group, Inc.

01/26/2023